

ARMY RESEARCH LABORATORY

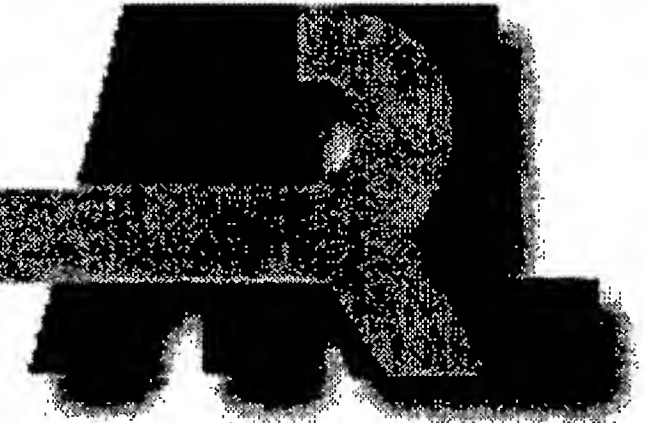

# Sniper Weapon Fire Control Error Budget Analysis

Raymond Von Wahlde  
Dennis Metz

ARL-TR-2065

AUGUST 1999

DTIC QUALITY INSPECTED 4

19990909 293

Approved for public release; distribution is unlimited.

Kevlar® is a registered trademark of E.I. DuPont de Nemours & Co., Inc.

MatchKing® is a registered trademark of Sierra Bullets.

Remington Model 700™ is a trademark of the Remington Arms Company, Inc.

The findings in this report are not to be construed as an official Department of the Army position unless so designated by other authorized documents.

Citation of manufacturer's or trade names does not constitute an official endorsement or approval of the use thereof.

Destroy this report when it is no longer needed. Do not return it to the originator.

# Army Research Laboratory

Aberdeen Proving Ground, MD 21005-5066

---

---

ARL-TR-2065

August 1999

---

## Sniper Weapon Fire Control Error Budget Analysis

Raymond Von Wahlde  
Weapons & Materials Research Directorate, ARL

Dennis Metz  
EAI Corporation

---

---

Approved for public release; distribution is unlimited.

---

---

---

---

## Abstract

---

In order to assess the value added by the application of fire control technology to sniper weapons, "error budgets" are developed as a function of range for several sniper weapon systems. A system is comprised of the weapon and its associated ammunition as well as the type of fire control technology provided that weapon. For this study, a total of four weapon-ammunition combinations were used and three levels of fire control sophistication were examined. The "baseline system" consists of a two-person sniper team using a standard rifle, spotting scope, and laser range finder to make aiming corrections. The "cross-wind system" adds a laser crosswind sensing device and more accurate range finder incorporated into the spotting scope. The "fire control system" performs a full ballistic firing solution and presents a real-time corrected aim point to the shooter. One-sigma system errors and probabilities of hit against an E-silhouette target are calculated.



## TABLE OF CONTENTS

	<u>Page</u>
LIST OF FIGURES .....	v
LIST OF TABLES .....	vii
1. INTRODUCTION .....	1
2. WEAPON-AMMUNITION COMBINATIONS .....	2
2.1 M24 Sniper Weapon System (SWS), 300 Winchester Magnum Ammunition . . . .	2
2.2 M82A1 .50-Caliber Semi-Automatic Rifle, MK211 Ammunition .....	3
2.3 SR-25 Sniper Support Weapon (SSW), M118LR Ammunition .....	4
2.4 .338 Caliber Test Bed Rifle, .338-.416 Ammunition .....	5
3. CHARACTERIZATION OF FIRE CONTROL SYSTEMS .....	5
3.1 Baseline System .....	6
3.2 Crosswind Sensor System .....	6
3.3 Fire Control System .....	7
4. ERROR BUDGET ANALYSIS .....	7
4.1 Variable Bias and Random Errors .....	8
4.2 Error Sources .....	9
4.3 Error Budget Results .....	19
5. CONCLUSIONS .....	30
REFERENCES .....	31
APPENDICES	
A. Aeroballistic, Trajectory, and Unit Effects Data .....	35
B. Random and Variable Bias Errors .....	53
C. Number of Rounds to Hit E-Silhouette Target .....	59
D. Sensitivity Analysis .....	65
DISTRIBUTION LIST .....	71
REPORT DOCUMENTATION PAGE .....	75

INTENTIONALLY LEFT BLANK

## LIST OF FIGURES

<u>Figure</u>		<u>Page</u>
1.	M24 Sniper Weapon System (SWS) . . . . .	3
2.	Barrett Model 82A1 Semi-Automatic Rifle . . . . .	3
3.	SR-25 .30 Caliber Match Rifle . . . . .	4
4.	.338 Test Bed Rifle . . . . .	6
5.	Variable Bias and Random Errors . . . . .	9
6.	Horizontal Variances, .300 WM, 700 m . . . . .	24
7.	Vertical Variances, .300 WM, 700 m . . . . .	24
8.	Bias Errors, .300 WM, 700 m . . . . .	26
9.	Random Errors, .300 WM, 700 m . . . . .	26
10.	Total Errors, .300 WM, 700 m . . . . .	27
11.	Error Budget Sensitivity, Crosswind Variable Bias . . . . .	28
12.	Error Budget Sensitivity, Ranging Error . . . . .	29

INTENTIONALLY LEFT BLANK

## LIST OF TABLES

<u>Table</u>		<u>Page</u>
1.	Target/Weapon/Range Run Matrix . . . . .	1
2.	Error Sources . . . . .	10
3.	Round-to-Round Dispersion (RRD) Errors . . . . .	11
4.	Sniper's Approximate Aiming Error (unstressed, non-operational conditions) . . .	16
5.	Error Budget .300 WM . . . . .	20
6.	Error Budget MK211 . . . . .	21
7.	Error Budget M118LR . . . . .	22
8.	Error Budget .338-.416 . . . . .	23

INTENTIONALLY LEFT BLANK

# SNIPER WEAPON FIRE CONTROL ERROR BUDGET ANALYSIS

## 1. INTRODUCTION

Project White Feather is a U.S. Special Operations Command (SOCOM)-sponsored effort to apply advanced sniper weapon fire control technology that will extend range and increase first round hit probability for special operations applications.[1] As envisioned, the fire control will provide the shooter a real-time ballistically corrected aim point with input from a laser crosswind sensor, laser range finder, inertial sensors that measure weapon motion, as well as other sensors.[2]

In order to assess the value added by the application of fire control technology to sniper weapons, SOCOM commissioned a weapon effectiveness study.[3] The analysis followed the procedures of the *Special Operations Target Vulnerability and Weaponing Manual*. [4] Although the manual is devoted to specific targets, it delineates a method for determining target vulnerability. The process involves creating a target description, defining damage criteria, characterizing the weapon, computing hit points, and ascertaining weapon effectiveness. The output is the number of rounds required to achieve a probability of kill (Pk) of 0.95 against a target.

A weapon system is comprised of the weapon and its associated ammunition, as well as the type of fire control technology provided for that weapon. For the study in Reference 3, three weapon-ammunition combinations were used, and three levels of fire control sophistication were examined. A set of seven land targets was chosen that represent both tactical and strategic/operational targets. Two ranges were used for each target; each target was addressed by two weapons. The run matrix is shown in Table 1.

Table 1. Target/Weapon/Range Run Matrix

Target	Weapon/Ammunition		Range (m)	
Target Acquisition Radar	M24 300 WM	M82A1 MK211	1200	1500
Communications Van	M24	M82A1	1200	1500
Tanker Truck	M24	M82A1	1200	1500
Electric Power Transformer Substation	M24	M82A1	1200	1500
Antitank Guided Missile Launcher	M24	M82A1	400	700
Commander's Periscope, Tank	M24	SR-25 M118LR	400	700
Commander's Periscope, Combat Vehicle	M24	SR-25	400	700

As its contribution to the weapon effectiveness study, the U.S. Army Research Laboratory (ARL) characterized the ammunition in terms of aeroballistics, trajectories, and unit effects data for changes in muzzle velocity, range, wind, and other parameters. An error budget was developed as a function of range for each weapon-ammunition-fire control combination. Standard deviation values were chosen for each source of error considered to influence accuracy. The resulting computed dispersion data were used in probability of hit (PH) calculations for each system. This report documents the derivation of the error budgets. To compute PH, an E-silhouette (crouching man) target is used instead of the vulnerable areas of the targets from the weapon effectiveness study.

## **2. WEAPON-AMMUNITION COMBINATIONS**

A set of three weapons (and accompanying ammunition) that are currently available to the U.S. military sniper community were used in the sniper operations analysis. This report also includes a bench rest, 0.338-inch caliber weapon to represent the possible performance from a future sniper rifle, e.g., the objective sniper weapon (OSW).[5]

### **2.1 M24 Sniper Weapon System (SWS), 300 Winchester Magnum Ammunition**

The U.S. Army's M24 sniper weapon system (SWS) is built on a Remington Model 700™ bolt action and is chambered for 7.62x51-mm North Atlantic Treaty Organization (NATO) caliber ammunition. The receiver is also capable of conversion to fire 300 Winchester magnum (WM) rounds. The adjustable length stock (manufactured by H.S. Precision) is made of a composite of Kevlar®, graphite, and fiberglass bound together with epoxy resins and features an aluminum bedding block and adjustable plate. A detachable bipod (manufactured by Harris) can be attached to the stock fore end. The length of the M24 rifle is 1.092 meters (43 in.). The weight of the empty rifle without the scope is 5.49 kilograms (12.1 lb). The 610-mm (24-in.) barrel has rifling with five lands and grooves, a right-hand twist, and one turn in 285 mm (11.25 in.). The ammunition feed is a five-round integral magazine. The reported maximum effective range for the M24 is 800 meters.[6] A photograph of the M24 SWS is provided in Figure 1.

Magnum is a term commonly used to describe a cartridge or rifle that is larger or produces higher velocity than standard cartridges or rifles of a given caliber.[7] 300 WM come in 180, 190, 200, and even 220 grain sizes. For this study, a 190-grain (12.3-gm), MatchKing® (MK), hollow point boat tail (HPBT), .30-inch caliber bullet was chosen and was assumed to be fired with a



muzzle velocity of 884 m/s (2,900 ft/s). The aeroballistic, trajectory, and unit effects data for the 300 WM are presented in Appendix A.

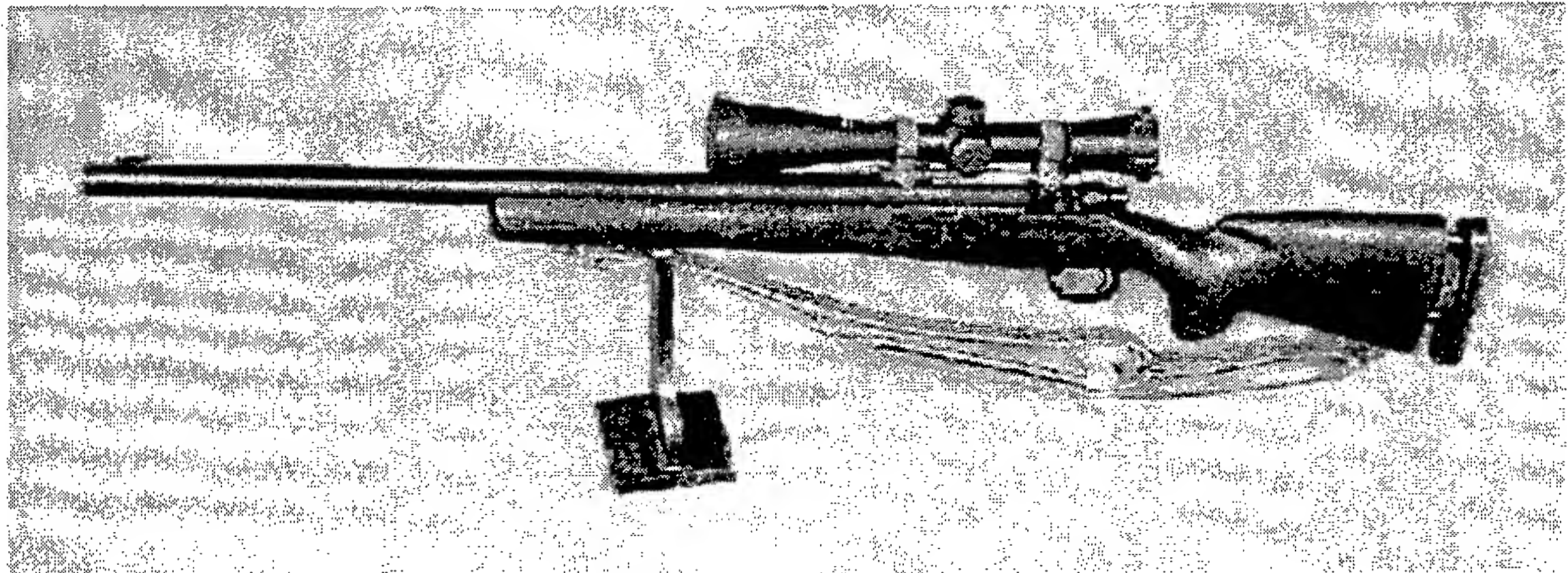

Figure 1. M24 Sniper Weapon System (SWS).[8]

## 2.2 M82A1 .50-Caliber Semi-Automatic Rifle, MK211 Ammunition

The U.S. Army's M82A1 .50-caliber semi-automatic rifle is manufactured by Barrett Firearms Manufacturing, Incorporated.[9] The M82A1 is an air-cooled, box-magazine-fed rifle chambered for the .50-caliber, M2 Browning machine gun cartridge. The rifle operates by means of a short recoil principle. The basic rifle is equipped with a bipod, muzzle brake, carrying case, and metallic sights. The ammunition feed is a 10-round detachable box magazine. The overall length of the M82A1 weapon is 1448 mm (57 in.) and the length of the barrel is 737 mm (29 in.). The weight of the weapon is about 13.6 kg (30 lb). The M82A1 can fire either the M33 ball round or the MK211 multipurpose (MP) round. The MK211 round was selected for this study. The reported maximum effective range on equipment-sized targets is 1800 m.[10] A photograph of the M82A1 is presented in Figure 2.

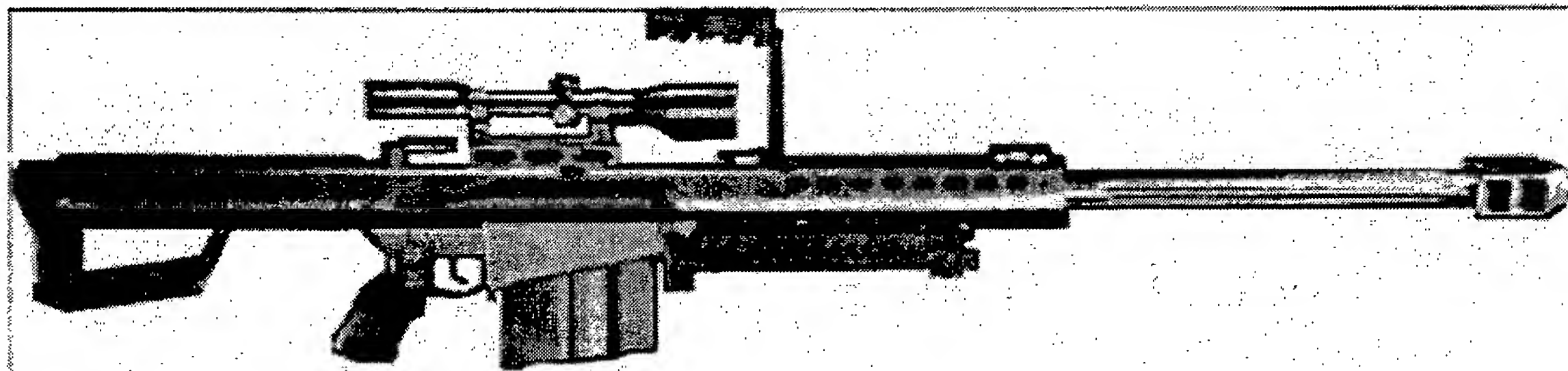

Figure 2. Barrett Model 82A1 Semi-Automatic Rifle.[11]

The MK211 MP is a 670-grain (43.4 gm), .50-caliber bullet manufactured by Raufoss in Norway. The MK211 MP projectile has an armor penetrator, an incendiary component, and a high explosive component consisting of RDX (cyclonite), which is the explosive component of C-4.[12] The MK211 multipurpose cartridge is suited for targets such as lightly armored troop carriers, trucks, helicopters, light airplanes, and water craft. In addition, the MK211's Zirconium-initiated incendiary and fire-starting capability is effective against fuel and ammunition storage containers and vehicle fuel tanks.[13] For this study, the round was assumed to be fired with a muzzle velocity of 827.5 m/s (2,715 ft/s). The aeroballistic, trajectory, and unit effects data for the MK211 MP are given in Appendix A.

### 2.3 SR-25 Sniper Support Weapon (SSW), M118LR Ammunition

The SR-25 sniper support weapon (SSW) is a semi-automatic .308 Winchester (7.62-mm NATO rifle) produced by Knight's Manufacturing Company. The SR-25 has several versions. The version designated the SR-25 match rifle is the SR-25 SSW.[14] The SR-25 bears a strong resemblance to the M16/AR-15 family of rifles. This is because one of the designers of the SR-25 was Eugene Stoner ("SR" stands for "Stoner rifle"), who was the original designer of the Armalite AR-15 series of rifles that was adopted by the U.S. military as the M16 family of assault rifles. In fact, 60% of the parts of the SR-25 are common to the M16/AR-15 family. A picture of the SR-25 match rifle is presented in Figure 3.

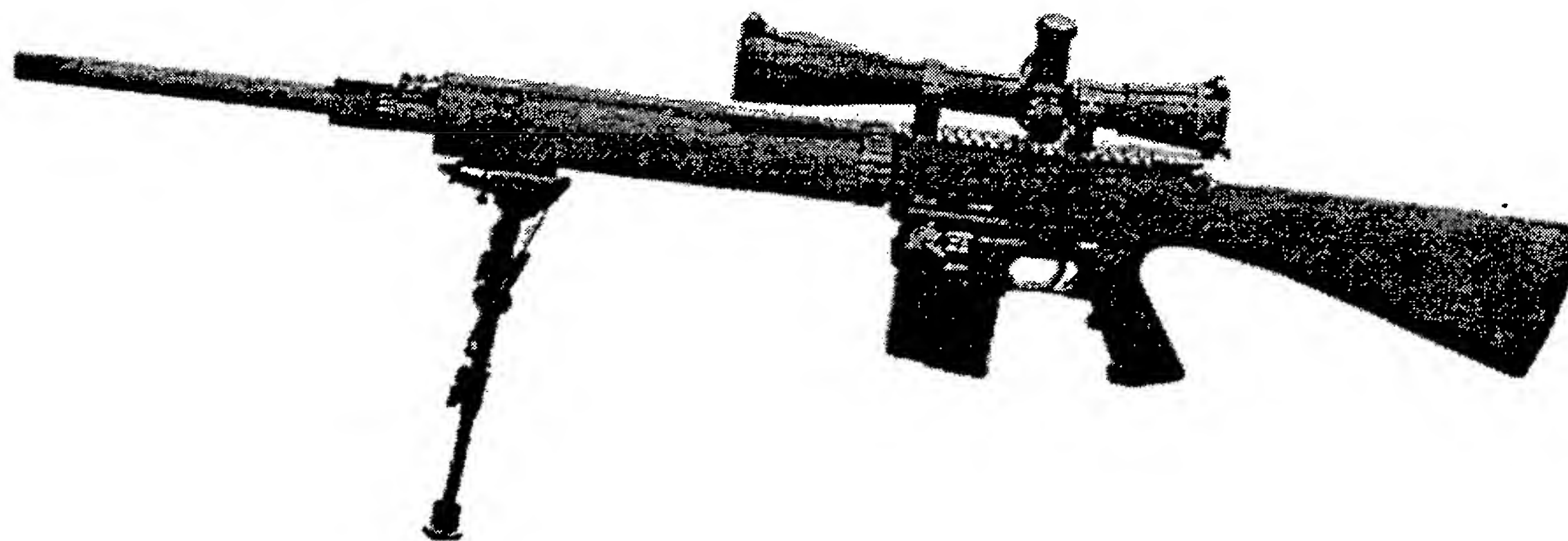

Figure 3. SR-25 .30 Caliber Match Rifle.[15]

The SR-25 operates on an air-cooled, direct gas system. There are no moving parts attached to the free floating barrel to interfere with its vibrations. The barrel is made from the same type of hammer-forged blank used by Remington to build the M24 SWS. The barrel for the

SR-25 match rifle has a length of 610 mm (24 in.). The overall length of the rifle is 110 mm (43.5 in.). The unloaded weight without optical sight and mounts is 4.87 kg (10.75 lb).[16]

The reported maximum effective range for the SR-25 rifle is 900 m (1,000 yd). It is claimed that there are few .308 bolt-action sniper or match rifles that can consistently shoot tighter groups than a well-broken-in SR-25.[15] The SR-25 rifle has not yet been currently adopted by the U.S. military services. A possible U.S. Army application of the SR-25 is as a support weapon in sniper teams where the “second soldier” can have a local defense function in addition to using the SR-25 as a replacement rifle, should the main sniper rifle become disabled for any reason.

The ammunition selected for the SR-25 SSW is the U.S. Army currently inventoried M118 long range (LR) sniper cartridge. The M118 LR cartridge uses a 175-grain (11.34 gm) Sierra HPBT match bullet. Slightly heavier than either the military 173-grain or Sierra 168-grain bullet it replaces, the M118 LR retains more momentum to stretch the 7.62-mm effective range 100-plus.[17] For this study, the round was assumed to be fired with a muzzle velocity of 792.5 m/s (2,600 ft/s). The aeroballistic, trajectory, and unit effects data for the M118 LR are given in Appendix A.

#### 2.4 .338 Caliber Test Bed Rifle, .338-.416 Ammunition

The rifle shown in Figure 4 is a 0.338-inch caliber, bench rest-grade, precision rifle. It has a Hall Model E bolt action. The 914-mm (36-in.) Obermeyer barrel is rifled for one turn in 254 mm (10 in.). The rifle is chambered for a .416 Rigby brass cartridge case, tapered to hold a custom designed 300-grain .338 Sierra MatchKing® HPBT projectile.[18] This bullet was designed to have low drag, a high ballistic coefficient, short time of flight, and flat fire—all the factors necessary to achieve low crosswind sensitivity. Its muzzle velocity is 923.3 m/s (3,030 ft/s). The aeroballistic, trajectory, and unit effects data for the .338-.416 are given in Appendix A.

### **3. CHARACTERIZATION OF FIRE CONTROL SYSTEMS**

Three different levels of fire control sophistication were identified for consideration as potential system configurations for sniper usage. Each succeeding configuration augments the previous one to advance firing accuracy. They represent both a consistent and reasonable progression from currently fielded capability to substantially improved performance by employing various degrees of the fire control technology and functionality that have been developed and implemented for other tactical applications.



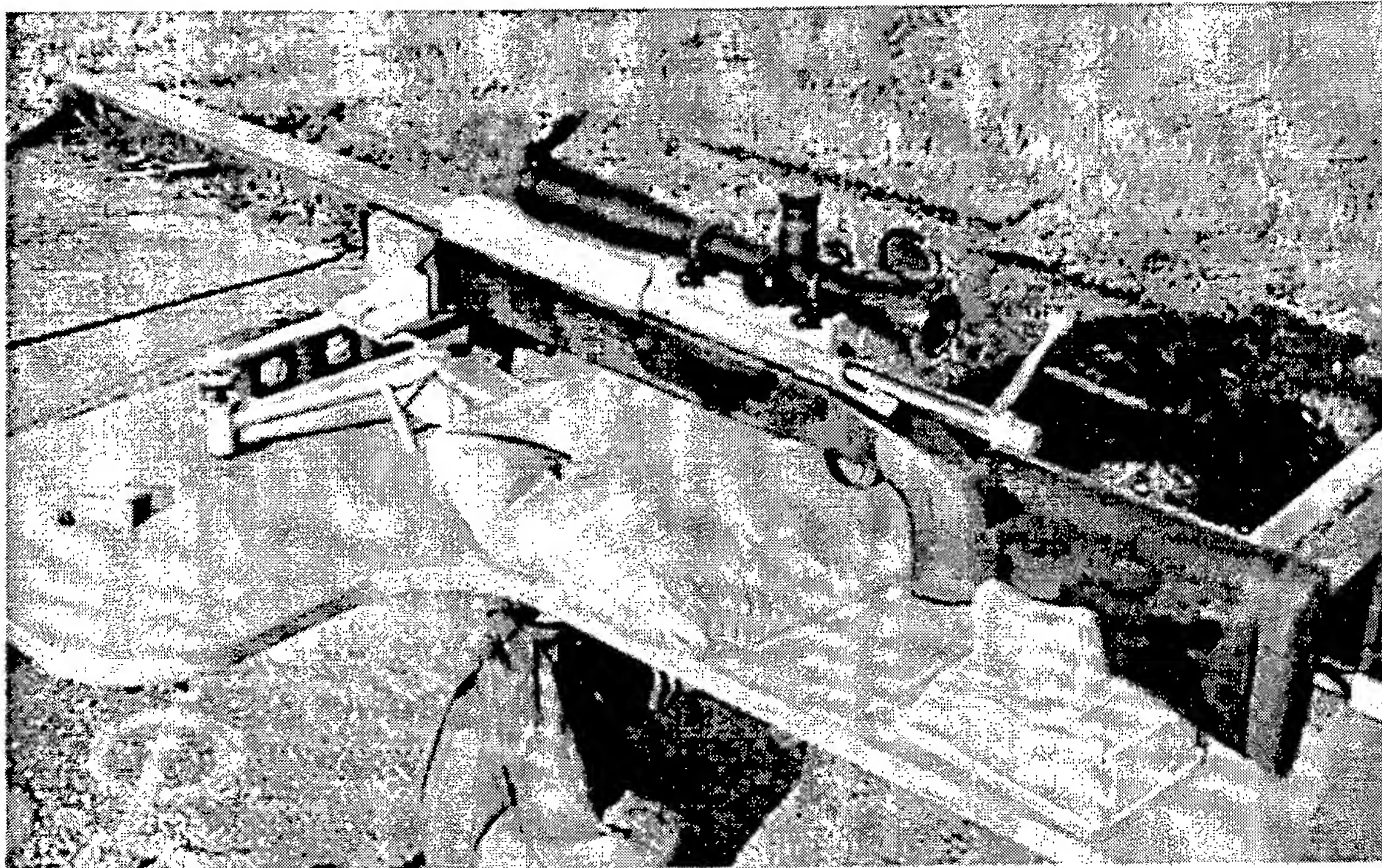

Figure 4. .338 Test Bed Rifle.

### 3.1 Baseline System

The first level of fire control system is referred to as “baseline.” This system is representative of the way current two-person sniper teams perform “fire control” by manually adjusting elevation and azimuth, based on estimates or measurements of range, crosswind, and other effects that the sniper or spotter feel are necessary for their tactical situation. The equipment provided in this system consists of a 10-power optical sight on the rifle and a 20x spotting scope. Also included is a mini eye-safe laser infrared observation (MELIOS)-type laser range finder. Crosswind is estimated by the spotter. Ballistic corrections are obtained from “lookup” tables, personal notes, or based on experience.

### 3.2 Crosswind Sensor System

The second fire control configuration, “crosswind sensor,” augments the baseline system by providing a spotting scope that will incorporate both a more accurate laser range finder and a down-range crosswind sensor. This device will use laser technology to ensure that the prevailing crosswind component in any engagement scenario is included in a fire control solution. The aim point correction is still called by the spotter to the shooter who then manually adjusts the optical sight.

### 3.3 Fire Control System

The third and most sophisticated fire control system is referred to as "fire control." This system is comprised of the appropriate equipment required to perform a real-time, full ballistic firing solution for the sniper. Readings from the same accurate laser range finder and crosswind sensor used in the crosswind system are input directly into a ballistic computer. Sensors account for other meteorological effects such as air temperature and air density. Inertial sensors measure and compensate for weapon motion, providing the shooter with a stabilized reticle. In addition, a real-time, corrected aim point is presented to the shooter. The shooter fires the weapon by bringing the inertial and corrected aim points into convergence.

## 4. ERROR BUDGET ANALYSIS

To assess a weapon system's accuracy, an error budget is constructed. An error budget is a systematic account of the sources of error in a system.[19] For this analysis, the system is a sniper weapon and the error is bullet dispersion at the target. An error budget can be used to estimate the accuracy of a weapon and can also help to identify the major contributors to overall dispersion. To form an error budget, one must

- (a) Estimate the magnitude and statistical distribution of the error sources;
- (b) Model the mechanism that converts the error source into system error; and
- (c) Combine errors from various sources.

The first task is a difficult but important one. Any results from an error budget will only be as good as the estimates of the error sources. For this report, a thorough attempt was made to determine values for all the significant sources of firing error considered to influence accuracy and to compute the effects these errors have on bullet dispersion.[20] All error sources are assumed to have normal distributions and are given as one standard deviation (sigma) values. Ideally, they are measured from firing tests, e.g., the standard deviation in muzzle velocity determined from a chronograph.

The second task has been accomplished by calculating unit effects from a trajectory model. Unit effects are changes in the path of the bullet because of unit differences in an error source, e.g., the change in height because of a unit change in muzzle velocity. Appendix A contains the unit effects computed for each of the bullets used for this report. The ballistic dispersion caused by a given error source is that source's standard deviation multiplied by its unit effect.



For the third task, the error sources are assumed to be independent of each other. Thus, the total dispersion is the square root of the sum of the squares of each error. Dispersion is computed for both the vertical and horizontal planes and is given as a standard deviation. It is given in a common (but often misunderstood) unit of angle in sniping, the Army “mil,” as in a “mil-dot” scope. A mil is a rounded value for a milliradian. A circle has  $360^\circ$  or two pi radians of interior angle. Two pi multiplied is 6.2832 radians or 6283.2 milliradians. To simplify, the military uses 6400 mils to one circle. This rounding eases division by 2. This approximates the common belief that a mil is one meter at 1000 meters (or 1 yard at 1000 yards).

#### 4.1 Variable Bias and Random Errors

The sources of firing errors are grouped in two categories: variable bias errors and random errors.[21] Variable bias errors are those that vary from firing occasion to firing occasion but remain fixed from round to round on any given occasion. They are the errors introduced by the particular nonstandard conditions prevalent on a given occasion, which generally vary from occasion to occasion. These include errors resulting from estimates or measurements of factors such as crosswind or range, as well as occasion-to-occasion variation in other firing conditions such as the cant of the weapon or error introduced during the process of zeroing the weapon.

Random errors are those that vary from round to round on a given firing occasion. These include round-to-round differences in ammunition performance, the effects of crosswind and range wind gustiness, and round-to-round aiming error. A detailed list and definitions of all the variable and random errors included in this analysis are presented in Section 4.2.

To illustrate variable and random errors, consider the E-silhouette target in Figure 5. The long dashed ellipse represents a  $\pm 1$  sigma of the variable bias errors in the horizontal and vertical directions. On a given firing occasion, errors introduced by inaccuracies in crosswind estimation, ranging to target, emplacement of the weapon, etc., will **bias** the first and any subsequent shots from the intended point of impact. The plus symbols show some bias errors randomly generated from the variable bias sigma distribution. The bias error varies from occasion to occasion. Now consider the “X” symbol that represents the bias for one such arbitrary firing occasion. In addition to this bias error, there will also be the random, shot-to-shot error introduced by changes in the crosswind from the estimated value, weapon pointing differences, muzzle velocity variations, round dispersion, etc. The short dashed ellipse, centered about the “X,” represents a  $\pm 1$  sigma of the random, shot-to-shot errors. The circles are a shot group randomly generated using the random error sigma distribution. A shot group is randomly distributed about a center of impact. This center of impact can be envisioned as being variably biased from one occasion to

the next. The total system error is the root sum square of all the individual variable bias and random errors.

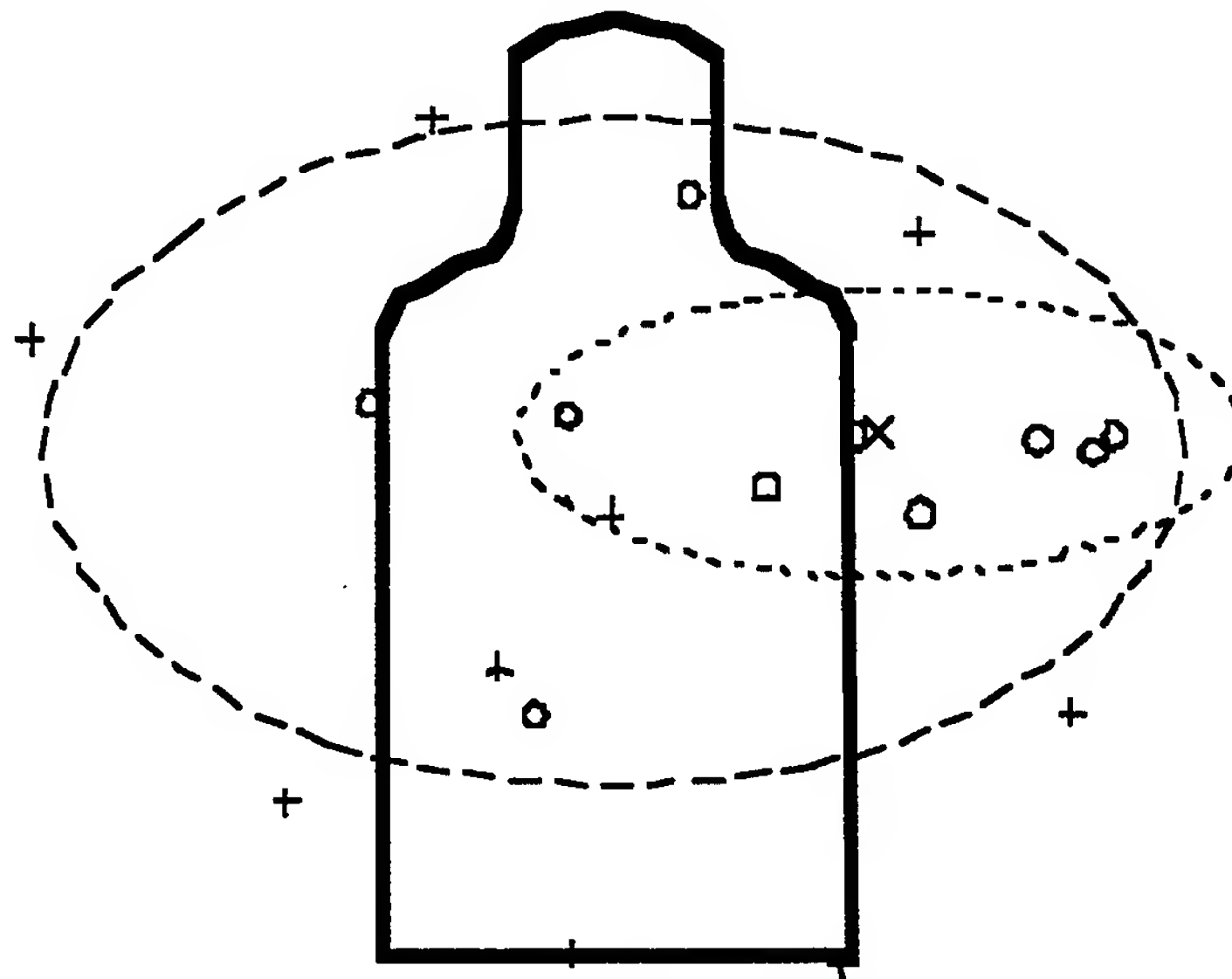

Figure 5. Variable Bias and Random Errors.

#### 4.2 Error Sources

The error sources and the standard deviation values selected for this analysis are summarized in Tables 2 and 3. Explanations for the chosen error values are given in the following sections.

##### 4.2.1 *Windage*

The wind experienced during a projectile's time of flight can be resolved into two components: crosswind and range wind. Crosswind is the horizontal component of the wind vector perpendicular to the trajectory. Crosswind deflects a bullet off the line of fire. Range wind is the component along the trajectory. A head wind blows from down range to up range, into the face of the shooter, slightly slowing the bullet's speed, causing the shot to hit low. A tail wind blows at the shooter's back, slightly increasing the bullet's speed, causing the shot to go high. A shooter's ability to estimate wind magnitude and direction or a crosswind sensor's accuracy determines the level of windage error.

Shooters estimate wind speed and direction using a number of techniques and rules of thumb. To ascertain speed, a spotter senses the feel of the wind on his or her face, observes the motion of foliage, dust, etc., and/or looks at "mirage," i.e., the refraction or distortion of light from the target as it passes through layers of air of different temperatures and densities, caused

by the heat coming off the ground. As observed through a defocused sight or spotter scope, this shimmer will appear to move with the same velocity as the effective wind.

Table 2. Error Sources

Error Source	System		
	Baseline	With CW Sensor	With Fire Control
Variable Bias Errors (occasion to occasion)			
Crosswind (mph)	5	2 1/4	0
Range Wind (mph)	10	1 1/8	0
Ranging	5% of Range	1m	1m
Weapon Cant (degrees)	1	1	0
Muzzle Velocity (ft/s)	15	15	15
Air Temperature Change (percent)	15	15	0
Air Density Variation (percent)	1.5	1.5	0
Weapon-Target Altitude (degrees)	2	2	0
Horizontal Zeroing Error (mil)			
M24/300WM	0.05	0.05	0.04
SR25/M118LR	0.05	0.05	0.04
M82A1/MK211	0.09	0.09	0.07
Vertical Zeroing Error (mil)			
M24/300WM	0.04	0.04	0.04
SR25/M118LR	0.04	0.04	0.04
M82A1/MK211	0.09	0.09	0.07
Random Errors (shot to shot)			
Crosswind (mph)	3	3	2 1/4
Range Wind (mph)	3	3	1 1/8
Ranging (m)	0	0	0
Weapon Cant (degrees)	1/10	1/10	0
Weapon Pointing (mil)			
M24/300WM	0.1	0.1	0.1
SR25/M118LR	0.1	0.1	0.1
M82A1/MK211	0.2	0.2	0.1
Muzzle Velocity (ft/s)	15	15	15
Round Dispersion (mil)	(See Table 3)		
Air Temperature Change (percent)	0.5	0.5	0.3
Air Density Variation (percent)	0.5	0.5	0.3
Weapon-Target Altitude (degrees)	0	0	0
Sight Resolution (mil)	0.06	0.06	0.02
Optical Path Bending (mil/m)	0.00003	0.00003	0.00003



Table 3. Round-to-Round Dispersion (RRD) Errors

Horizontal and Vertical Round-to-Round Dispersions (mils)			
Range (m)	M118 LR and 300WM	MK211, .50 CAL	Test bed, 338-416
100	0.099	0.187	0.035
200	0.105	0.198	0.047
300	0.114	0.212	0.055
400	0.125	0.227	0.061
500	0.139	0.244	0.067
600	0.156	0.262	0.072
700	0.176	0.282	0.077
800	0.198	0.303	0.081
900	0.223	0.325	0.085
1000	0.250	0.349	0.089
1100	0.281	0.373	0.092
1200	0.314	0.398	0.095
1300	0.349	0.425	0.098
1400	0.388	0.452	0.101
1500	0.429	0.480	0.104

To determine direction, shooters employ a clock face system in which 12:00 is pointing down range, 6:00 is behind the shooter, and 3:00 and 9:00 are to the right and left of the firing line, respectively. A wind coming from 12:00 or 6:00 is called a “no value” wind in terms of crosswind. A wind from about 2:00 to 4:00 or 8:00 to 10:00 is called a “full value” wind. Winds coming from about 1:00, 5:00, 7:00, or 11:00 are “half value” winds. Thus, for example, if a shooter estimated wind speed at 15 mph coming from 7:00, he or she would attempt to correct for a crosswind of about 8 mph blowing from left to right.[22]

Some shooters carry small anemometers in their rucksacks for an actual measurement of the wind at their location. They may read the wind at several locations and mentally “average them together.” Mainly, however, a sniper relies on “Kentucky Windage,” an intuitive sixth sense that a shooter develops with experience wherein he or she consciously or unconsciously recalls similar experiences and just “knows” by how much to adjust the aim point. However the shooter achieves a value, the underlying assumption is that the wind velocity is constant from the shooter to the target. However, the wind experienced by a bullet in flight can, and most likely does, vary with terrain. For any given bullet deflection at a particular range, there are an infinite number of

intervening crosswind profiles, only one of which is a constant, uniform wind, which would result in the same deflection. It is this effective crosswind profile that a shooter or sensor is tasked with determining.

Wind also varies over time. The effective crosswind (and range wind) can be thought of as fluctuating randomly about some mean value that is averaged over an arbitrary period of time. The mean value will result in a bias of a shot group off the aim point. The random fluctuations about the mean will disperse the group about the mean bias. The accuracy to which the mean value is estimated or measured results in a windage variable bias error. The extent to which the random fluctuations about the mean are compensated for determines the windage random error.

#### 4.2.1.1 Windage Baseline System

In the baseline system, wind speed and direction are estimated by a spotter. He or she then uses this estimate of the mean effective crosswind profile to calculate an aim point correction. The spotter relays this to the shooter who adjusts the windage knob on the rifle scope. If the wind changes, the spotter may have the shooter refrain from firing until the conditions repeat.

It is assumed that the mean effective crosswind profile is estimated to no better than 5 mph. This is probably a generous assumption, especially at longer ranges. The value is deduced from several sources. First, tables in sniper training manuals list wind effects on the surrounding environment in 3- to 6-mph increments, indicating that shooters “call” the wind in roughly 5-mph increments.[23, 24] Often, a shooter waits for an apparent lull in the wind before pulling the trigger. According to the manuals, a 3- to 5-mph wind “can just be felt on the face,” which could be interpreted as a “calm condition.” Thus, 5 mph is consistent with these tables. Another reason comes from the shooters themselves. The small arms common module fire control system (SACMFCS), developed by Contraves [25], had a Micro-Bridge mass air flow sensor (a heated Wheatstone-bridge-type device made by Micro-Switch, a division of Honeywell [26]) on board to measure crosswind. Shooters, rightfully doubtful of the anemometer’s utility, were given the ability to override the measured crosswind and enter their estimate. When asked how they wanted to enter their value, the shooters replied that they wanted to be able to select among 0, 5, 10, and 15 mph.[27] This indicates that the shooters themselves recognize their limited ability to estimate crosswind.

Because it has a relatively small effect on the vertical deflection of the bullet, range wind is not typically a concern to shooters. So, unless it is noticeably large, shooters would

probably make no correction for it. From the training manual, leaves and twigs are in constant motion when the wind is blowing between 8 and 12 mph.[24] This would definitely be noticed by a shooter. However, if this were a head or tail wind, the shooter would probably make no conscious correction for it. Ten mph is selected as a midway value.

Thus, for the baseline system, the variable bias errors for the cross and range winds are chosen to be 5 and 10 mph, respectively. From one occasion to the next, a shot group would, on average, be biased by an amount these winds would cause. The variability of the wind during a single, short-duration firing event would probably be less; however, no adjustment is made for it. Three mph for both cross and range winds is used for the random, shot-to-shot error. This value comes from anemometer data acquired during actual firing events.

#### 4.2.1.2 Windage Crosswind and Fire Control Systems

Two techniques employed in laser crosswind sensors, which are being developed, are Doppler velocimetry and scintillation. In the Doppler approach, the velocities of atmospheric aerosols (dust, water vapor, etc.) are measured along divergent laser beams on both sides of the firing line. These are resolved into cross and range wind components. The advantage to this technique is that it provides a range-resolved reading of the crosswind profile rather than a single value of the intervening crosswind. Theoretically, it might also provide very accurate measurements of the wind speed, probably 1/2 m/s (1.125 mph).[28] A disadvantage is the need for divergent beams that could impinge on down-range obstacles (e.g., a tree line). Another problem is that unless the wind is constant from beam to beam, the measured velocities cannot be directly resolved into a crosswind.

In the scintillation technique, the target is illuminated by a laser. Weighted averages of the intervening crosswind are determined from the distortion of the reflected scintillation or "twinkle" pattern of the laser light.[29] Because it only requires a single beam along the line of fire, a crosswind sensor using the scintillation technique would be the most practical to a sniper. A disadvantage of this method is that it provides only a weighted average rather than a range-resolved measurement of the crosswind. This can be somewhat offset by having multiple weighted readings. It is assumed that there will be enough weighted readings to measure the effective crosswind to within 1 m/s (2.25 mph). The Doppler technique would still be employed to give range wind to within 0.5 m/s. The whole system would be constructed from lightweight, compact, rugged, fiber-optic laser components and would be incorporated into a spotting scope.[30]

In the system with a separate crosswind sensor, the spotter would call the windage correction to the shooter as is done with the baseline system—only with more accuracy. Thus, the variable bias windage errors for the crosswind sensor system are 2.25 mph and 1.125 mph for cross and range winds, respectively. Because the shooter does not instantaneously adjust for windage called by the spotter, there will be some variability of the wind between the time the spotter calls the correction and the moment the sniper makes the shot. The wind will also change for any rapid, subsequent shots made by the sniper before he or she receives a new windage correction. Therefore, for the crosswind system, the random shot-to-shot windage errors remain the same as the baseline system, 3 mph for cross and range wind variability.

In the system with a full fire control, a nearly instantaneous reading of the effective cross and range winds will be made for each shot, and a corrected aim point will continually be presented to the shooter. Whatever the effective cross and range wind components are at that instant, they are determined to within the accuracy of the sensor, 2.25 mph and 1.125 mph, respectively. This results in a random error only.

#### 4.2.2 *Ranging*

Ranging error will result in a variable bias of the shot or shot group in the vertical direction. It is assumed that the baseline weapon system includes a MELIOS-type laser range finder operated on a tripod by a trained spotter in a prone position. The targets are of sufficient size to allow placement of a 1-mil-diameter aiming circle on them. The spotter's aiming skills and stable position ensure the laser return is coming from the target and not from surrounding or intervening features. Based on field test, even during such benign conditions, ranging errors with such a range finder are between 3.4% and 9.3% of distance, not the oft-reported 5-m intrinsic accuracy of the MELIOS.[31, 32] A value of 5% of distance is arbitrarily used because it is about midway between the field data. In addition, MELIOS only displays range in 5-m increments. For the 100-m range values for which error estimations were computed, 5% yields 5-m increments. The crosswind sensor and fire control weapon systems include an improved range finder as part of the crosswind sensor. A stated range accuracy by one of the crosswind sensor developers is 1 m.[28] Also, work done under the objective individual combat weapon has resulted in a laser range finder that works through clutter. For this study, the target is assumed to be stationary, so there is no random shot-to-shot ranging error.



### 4.2.3 *Round Dispersion*

Round or ammunition dispersion is what the bullets might be expected to do during the most ideal conditions, i.e., from a machine rest barrel, known range to target, zero pointing error, no wind, etc. Since no two projectiles of the same type are exactly alike because of tolerance differences, launch cycles, and other factors, no two rounds will follow the exact same trajectory. The amount of error varies from ammunition type to ammunition type and even between lots for one ammunition. Dispersion estimates are universally based on ammunition acceptance test data often at short ranges (e.g., 100 yd). Limitations in the instrumentation and procedures thereof may account for a certain portion of dispersion error.[32]

Round-to-round dispersion (RRD) values used for each of the ammunitions are listed in Table 3. More information concerning the source and choice of the data is given in Appendix A.

### 4.2.4 *Weapon Pointing (aiming) Error*

Weapon pointing error is the ability of a shooter to hold his or her aim on target. Any skilled sniper would claim that his or her weapon pointing error is zero. All misses arise from a cold barrel, a gust of wind, or some other vagary. In Reference 32, Table 2.19, the author summarizes his estimates for sniper's aiming error in a table that is worth reproducing here in its entirety for purposes of discussion (see Table 4).

The author of Reference 32 makes the point several times that all aiming error data he has ever seen represent rather benign, "peacetime" conditions, i.e., bull's-eye targets, known ranges, no combat stress, etc. He bemoans the "total absence of any test data from a test done in anything resembling an operational setting." Nevertheless, he states that the available data "provide an adequate basis for engineers to design effective materiel."

Rather than argue the point, it was decided to give the benefit of the doubt to the shooter. So the best values for a highly trained sniper, during benign conditions, were chosen from Table 4. For the baseline and crosswind systems, 0.1 mil was used for the M24, SR25, and 338-416 weapons, and 0.2 mil was used for the M82A1. To give a sense of size, this corresponds to holding one's bead within approximately 4- and 8-inch circles, respectively, at 1000 m. At the same time, since inertial sensors counteract weapon motion, it is felt that the fire control system will perform at least as well as the shooter, so 0.1 mil was used for all weapons. The horizontal and vertical aiming errors are assumed to be the same and constant across all ranges.

Table 4. Sniper's Approximate Aiming Error  
(unstressed, non-operational conditions)

SIGMA (MILS) - CONSTANT ACROSS RANGE				
	NOTE: Quality of Shooter:	[a] LEVEL 1 Operational Sniper	[b] LEVEL 2 CP Perry Quality	[c] LEVEL 3 Williamsport Bench Rest
<u>CALIBER</u>	<u>Quality</u>			
Up to .300 Magnum (small caliber)	Best  Worst	0.30  0.80	0.10  0.30	0.03  0.10
> .300 Magnum (large caliber)	Best Worst	0.50 1.20	0.20 0.50	Not Estimated

- a. Example: Any service's operational snipers at entry level.  
b. Sufficiently trained to compete successfully in national level match competition; an experienced sniper on a good day.  
c. Taken by the author as representative of the top class of bench rest shooters; reported that this performance has been surpassed.
- Notes: - Aiming error sigma to be added to weapon/ammunition sigma; does not include range, wind, and other bias errors that offset center of impact from point of aim.  
- Based almost entirely on bull's-eye target, known range, practically unlimited time.

#### 4.2.5 *Weapon Cant*

Errors are introduced into the elevation and deflection calculations when the weapon is canted or rolled about its lengthwise axis because of uneven weapon emplacement. The baseline and crosswind sensor weapon systems rely on the shooter to level the weapon. Nevertheless, it is assumed that a trained sniper takes great care to emplace his or her weapon. When emplaced for the firing mission, the weapon is assumed to be level to within 1° standard deviation from the last time it was emplaced. During the firing mission, the cant is assumed to randomly vary no more than 1/10 of a degree from the value at which it was emplaced. For the fire control system, inertial sensors on the weapon will correct for cant.

#### 4.2.6 *Muzzle Velocity*

Deviations from the standard muzzle velocity will cause a round to fall short of or exceed the range to which it was fired. For a vertical target, the round will be below or above the intended point of impact. Muzzle velocity varies because of factors such as differences in powder temperature, inconsistent charge weights, ullage, tightness and condition of the bore, barrel length, action, shot order from a cold bore, etc. Few of these conditions can be corrected for by applying fire control. It is assumed that shooters carefully and consistently hand load

their cartridges and weigh charges for loads that will be used at 600 and 1000 yards or more. In addition, it is assumed that the powder charge completely fills the space in the cartridge under the bullet.

It would be impractical to have a temperature sensor with the stored ammunition and then have an expedient way to enter that reading into a fire control solution. It is assumed that ammunition will be kept close to the shooter's body to minimize temperature variations. For each system, no correction is made for muzzle velocity variation. A standard deviation in muzzle velocity of 4.5 m/s (15 ft/s) is considered to be feasible and is used for both lot-to-lot and shot-to-shot variations.[18] This is consistent with observations of muzzle velocity measurements of the 338-416. The standard deviation was 4 m/s (13 ft/s) for more than 80 rounds.

#### *4.2.7 Air Temperature and Density*

Air temperature variations during the firing event would probably be small because of the event's short duration. However, there could well be a difference in temperature between when the weapon was last zeroed and when the mission occurs. This would result in a bias of the shot pattern. For this study, trajectory runs were done at 21° C (70° F). It is not unreasonable to expect the temperature in a single day to vary at least  $\pm 10^{\circ}$  F, which is approximately a 15% deviation from the presumed temperature at the time of zeroing. For the baseline and crosswind sensor systems, it is assumed that a shooter would either make no correction for such a temperature change or would estimate the temperature to within 15%. All subsequent shots are then assumed to take place within a short time frame over which the temperature will not vary much. A value of 0.5% air temperature change is defined for test conditions as part of the error budget in Reference 33. The fire control system would include an air temperature gauge. Thus, the bias would be corrected for in real time, and the variation would be better accounted for, 0.3%.

Air density varies during the day and with changes in weather. Density also varies with altitude. Again, air density would not change significantly during the mission, but differences between zeroing and firing need to be accounted for. Reference 33 defines tactical firing conditions that use 1.5% air density change. This is used as the variable bias value for the baseline and crosswind sensor systems. A value of 0.5% air density change is defined as part of test conditions and is used for the random error. In the fire control system, air density itself would not be measured. It would be derived from measurements of air pressure and temperature. Thus, the bias would be corrected for in real time, and the variation would be better accounted for, 0.3%.

#### 4.2.8 *Weapon-Target Altitude*

If the sniper and the target are not at the same altitude, i.e., shooting up or down at the target, an error is introduced because the trajectory profile cannot simply be tilted.[33] The amount of error is generally small but increases as the difference in altitude increases. If a shooter fails to compensate for this or makes an error in estimating the correction, his or her shot group will be biased. However, with an assumed stationary target, the amount of error will not vary during the firing event. When zeroing, this value is  $0^\circ$ . For the baseline and crosswind sensor systems,  $2^\circ$ , the value used in Reference 33, is used. It is assumed that a shooter can estimate to within that error. The target is assumed to be stationary, so there is no random, shot-to-shot weapon-target altitude error. With the inertial sensors in the fire control system, the angle of the weapon is known, and this error source can be eliminated.

#### 4.2.9 *Zeroing*

At some time before the mission, the system will be calibrated through a live firing exercise. When a weapon is zeroed, the center of impact of a group of rounds is moved to the center of aim by adjusting the sight/weapon offset. Because a small number of rounds, typically fired during zeroing, cannot exactly determine the center of impact for all groups and to the extent that firing conditions such as wind, temperature, muzzle velocity, etc., are not perfectly known at zeroing, the procedure itself introduces an error. This is a variable bias error, not a random error. The method used in Reference 21 is used here to compute the zeroing error. The weapons are assumed to be zeroed at 100 m during benign conditions, i.e., known range, no wind, calm atmosphere. The sensors that are part of the fire control system account somewhat better for the environmental factors at the time of zero.

#### 4.2.10 *Sight Resolution*

Because human operators, optical sights, and electro-optical devices are not perfect, a factor is included in Reference 33 to account for the limits encountered in resolving images. The value used by Reference 33 (0.06 mil) is used for the baseline and crosswind sensor systems. Although this is a relatively small part of the error budget that could be considered a part of weapon pointing error, it was included to make the following distinction between systems. The inertial reticle technology, proposed as a key portion of the fire control, allows a 30x magnification of the target versus 10x from a regular scope. Thus, the sight resolution error for the fire control system is set to be one third of the baseline, 0.02 mil.



#### 4.2.11 Optical Path Bending

When viewed from a shooting position, the effects of atmospheric shimmer may cause a target to appear displaced from its actual location and possibly to seem to be moving when it is not. The effect can be greatly amplified by high temperatures and terrain reflectivity. The value used in Reference 33 is used here (0.00003 mil/m). Although video processing techniques that reportedly correct for this effect have been developed, they are not proposed as part of the fire control, and the system will not compensate for optical path bending.

#### 4.3 Error Budget Results

Using the error source values in Tables 2 and 3 and the unit effects derived from trajectory runs listed in Appendix A, the error budgets for each combination of weapon, ammunition, and fire control were developed as a function of range. The total system error is the root sum square of the random and variable bias errors. The horizontal and vertical dispersion values as a function of range are listed in Tables 5 through 8. These represent an expected error variation of one standard deviation. Statistically speaking, this means that approximately two thirds of the time, the error will be less than the value shown. The individual random and variable bias errors are presented in Appendix B.

The probabilities of hit (PH) in these tables are against an E-silhouette target represented by a vertical rectangle measuring approximately 0.5 meter horizontally and 0.85 meter vertically. The PHs are included for reference. Another way to view accuracy is to look at the number of rounds required to ensure at least one hit on the E-silhouette target with a confidence level equal to or greater than some percentage. These values are listed in the tables of Appendix C. It was assumed that no adjustment of fire is made for subsequent shots. The PH values are the confidence level when only one shot is fired.

To understand the relative contribution of each error source to the total system error, consider the .300 WM system at 700 m. The horizontal and vertical variances (square of the standard deviations) for each of the fire control systems are plotted in Figures 6 and 7. The plots show the total, bias, and random errors. Not surprisingly, the biggest portion of the horizontal variance is the crosswind bias and random errors. Likewise, the largest part of the vertical variance is attributable to ranging error. Other significant contributors to the total errors are round dispersion, weapon pointing, and cant errors.

Table 5. Error Budget .300 WM

Range (m)		Total System Errors (mil)											
		Baseline			w/ CW Sensor			w/ Fire Control			Round-to-Round Dispersion Only		
Horizontal	Vertical	PH*	Horizontal	Vertical	PH*	Horizontal	Vertical	PH*	Horizontal	Vertical	PH*	Horizontal and Vertical	PH*
100	0.20	0.16	1.00	0.16	1.00	0.16	0.15	1.00	0.16	0.15	1.00	0.10	1.00
200	0.29	0.19	1.00	0.17	1.00	0.18	0.15	1.00	0.18	0.15	1.00	0.11	1.00
300	0.41	0.22	0.96	0.17	1.00	0.23	0.16	1.00	0.22	0.16	1.00	0.11	1.00
400	0.55	0.28	0.75	0.19	0.91	0.30	0.18	0.99	0.26	0.18	0.99	0.13	1.00
500	0.70	0.35	0.53	0.20	0.72	0.38	0.19	0.89	0.31	0.19	0.89	0.14	1.00
600	0.87	0.45	0.34	0.23	0.53	0.48	0.21	0.74	0.38	0.21	0.74	0.16	0.99
700	1.05	0.57	0.20	0.26	0.39	0.58	0.23	0.58	0.44	0.23	0.58	0.18	0.96
800	1.24	0.73	0.11	0.30	0.28	0.83	0.26	0.44	0.52	0.26	0.44	0.20	0.89
900	1.46	0.93	0.06	0.36	0.19	0.97	0.30	0.32	0.60	0.30	0.32	0.22	0.77
1000	1.70	1.17	0.03	0.44	0.12	1.12	0.34	0.23	0.70	0.34	0.23	0.25	0.63
1100	1.96	1.48	0.02	0.55	0.07	1.30	0.39	0.16	0.80	0.39	0.16	0.28	0.50
1200	2.23	1.84	0.01	0.65	0.05	1.48	0.44	0.11	0.91	0.44	0.11	0.31	0.38
1300	2.49	2.20	0.01	0.72	0.03	1.65	0.50	0.08	1.01	0.50	0.08	0.35	0.28
1400	2.74	2.58	0.01	0.77	0.02	1.82	0.56	0.05	1.11	0.56	0.05	0.39	0.21
1500	2.98	2.99	0.00	0.82	0.02	1.98	0.62	0.04	1.21	0.62	0.04	0.43	0.15

\* Probability of Hitting an E-Silhouette target

Table 6. Error Budget MK211

Weapon: .50 Barrett M82A1 Ammo: MK211 Bullet Weight: 670 grains Muzzle Velocity: 2715 fps		Total System Errors (mil)											
Range (m)	Baseline			w/ CW Sensor			w/ Fire Control			Round-to-Round Dispersion Only			
	Horizontal	Vertical	PH*	Horizontal	Vertical	PH*	Horizontal	Vertical	PH*	Horizontal and Vertical	PH*		
100	0.31	0.30	1.00	0.30	0.29	1.00	0.23	0.22	1.00	0.19	1.00		
200	0.36	0.32	1.00	0.33	0.30	1.00	0.25	0.23	1.00	0.20	1.00		
300	0.44	0.34	0.95	0.37	0.31	0.98	0.27	0.25	1.00	0.21	1.00		
400	0.53	0.39	0.77	0.42	0.33	0.87	0.30	0.26	0.96	0.23	0.99		
500	0.63	0.44	0.55	0.48	0.34	0.70	0.34	0.28	0.86	0.24	0.96		
600	0.75	0.52	0.36	0.56	0.36	0.53	0.39	0.30	0.72	0.26	0.89		
700	0.88	0.61	0.22	0.64	0.39	0.39	0.43	0.33	0.56	0.28	0.78		
800	1.02	0.73	0.13	0.72	0.42	0.27	0.49	0.35	0.43	0.30	0.65		
900	1.17	0.86	0.08	0.82	0.45	0.19	0.54	0.39	0.31	0.33	0.53		
1000	1.33	1.03	0.05	0.92	0.49	0.13	0.61	0.42	0.23	0.35	0.42		
1100	1.50	1.22	0.03	1.03	0.55	0.09	0.67	0.45	0.17	0.37	0.33		
1200	1.68	1.45	0.02	1.15	0.61	0.07	0.74	0.49	0.12	0.40	0.26		
1300	1.87	1.73	0.01	1.28	0.68	0.05	0.82	0.54	0.09	0.42	0.20		
1400	2.07	2.03	0.01	1.41	0.76	0.03	0.90	0.59	0.06	0.45	0.16		
1500	2.27	2.36	0.01	1.55	0.83	0.02	0.97	0.64	0.05	0.48	0.12		

\* Probability of Hitting an E-Silhouette target

Table 7. Error Budget M118LR

Weapon: Knight SSW, SR25 Ammo: M118 LR Bullet Weight: 175 grains Muzzle Velocity: 2600 fps		Total System Errors (mil)											
Range (m)	Baseline			w/ CW Sensor			w/ Fire Control			Round-to-Round Dispersion Only			
	Horizontal	Vertical	PH*	Horizontal	Vertical	PH*	Horizontal	Vertical	PH*	Horizontal and Vertical	PH*	PH*	
100	0.21	0.17	1.00	0.18	0.16	1.00	0.16	0.15	1.00	0.10	1.00	1.00	
200	0.33	0.20	1.00	0.25	0.17	1.00	0.19	0.16	1.00	0.11	1.00	1.00	
300	0.47	0.24	0.93	0.33	0.18	0.99	0.23	0.17	1.00	0.11	1.00	1.00	
400	0.63	0.31	0.69	0.43	0.19	0.86	0.29	0.18	0.97	0.13	1.00	1.00	
500	0.81	0.41	0.46	0.54	0.21	0.65	0.35	0.20	0.85	0.14	1.00	1.00	
600	1.00	0.52	0.27	0.67	0.24	0.48	0.42	0.22	0.69	0.16	0.99	0.99	
700	1.20	0.67	0.15	0.80	0.28	0.34	0.50	0.25	0.53	0.18	0.96	0.96	
800	1.43	0.85	0.08	0.94	0.33	0.24	0.58	0.29	0.39	0.20	0.89	0.89	
900	1.67	1.07	0.05	1.10	0.39	0.16	0.68	0.33	0.28	0.22	0.77	0.77	
1000	1.92	1.33	0.03	1.27	0.46	0.10	0.78	0.38	0.19	0.25	0.63	0.63	
1100	2.19	1.63	0.02	1.44	0.54	0.07	0.88	0.44	0.13	0.28	0.50	0.50	
1200	2.43	1.94	0.01	1.61	0.61	0.05	0.98	0.49	0.09	0.31	0.38	0.38	
1300	2.67	2.27	0.01	1.77	0.66	0.03	1.07	0.55	0.07	0.35	0.28	0.28	
1400	2.89	2.61	0.00	1.92	0.76	0.02	1.16	0.61	0.05	0.39	0.21	0.21	
1500	3.11	2.98	0.00	2.07	0.88	0.02	1.25	0.67	0.04	0.43	0.15	0.15	

\* Probability of Hitting an E-Silhouette target

Table 8. Error Budget .338-.416

Range (m)		Total System Errors (mil)												
		Baseline			w/ CW Sensor			w/ Fire Control			Round-to-Round Dispersion Only			
	Horizontal	Vertical	PH*	Horizontal	Vertical	PH*	Horizontal	Vertical	PH*	Horizontal	Vertical	PH*	Horizontal and Vertical	PH*
100	0.14	0.13	1.00	0.14	0.13	1.00	0.12	0.11	1.00	0.035	1.00	0.035	1.00	
200	0.19	0.15	1.00	0.16	0.13	1.00	0.13	0.12	1.00	0.047	1.00	0.047	1.00	
300	0.26	0.17	1.00	0.20	0.14	1.00	0.15	0.12	1.00	0.055	1.00	0.055	1.00	
400	0.33	0.21	0.95	0.24	0.14	0.99	0.17	0.13	1.00	0.061	1.00	0.061	1.00	
500	0.41	0.25	0.79	0.29	0.15	0.92	0.19	0.14	0.99	0.067	1.00	0.067	1.00	
600	0.50	0.31	0.60	0.34	0.17	0.79	0.22	0.15	0.94	0.072	1.00	0.072	1.00	
700	0.59	0.37	0.42	0.40	0.18	0.64	0.25	0.15	0.85	0.077	1.00	0.077	1.00	
800	0.69	0.44	0.28	0.46	0.20	0.50	0.29	0.17	0.73	0.081	1.00	0.081	1.00	
900	0.79	0.53	0.18	0.53	0.23	0.39	0.33	0.18	0.61	0.085	1.00	0.085	1.00	
1000	0.91	0.63	0.11	0.61	0.27	0.29	0.37	0.19	0.50	0.089	1.00	0.089	1.00	
1100	1.03	0.75	0.07	0.68	0.32	0.21	0.41	0.21	0.40	0.092	0.99	0.092	0.99	
1200	1.16	0.88	0.05	0.77	0.38	0.14	0.46	0.23	0.31	0.095	0.97	0.095	0.97	
1300	1.30	1.04	0.03	0.86	0.45	0.10	0.51	0.26	0.24	0.098	0.95	0.098	0.95	
1400	1.44	1.23	0.02	0.95	0.54	0.07	0.56	0.28	0.18	0.101	0.92	0.101	0.92	
1500	1.60	1.44	0.01	1.06	0.65	0.04	0.62	0.31	0.14	0.104	0.89	0.104	0.89	

\* Probability of Hitting an E-Silhouette target

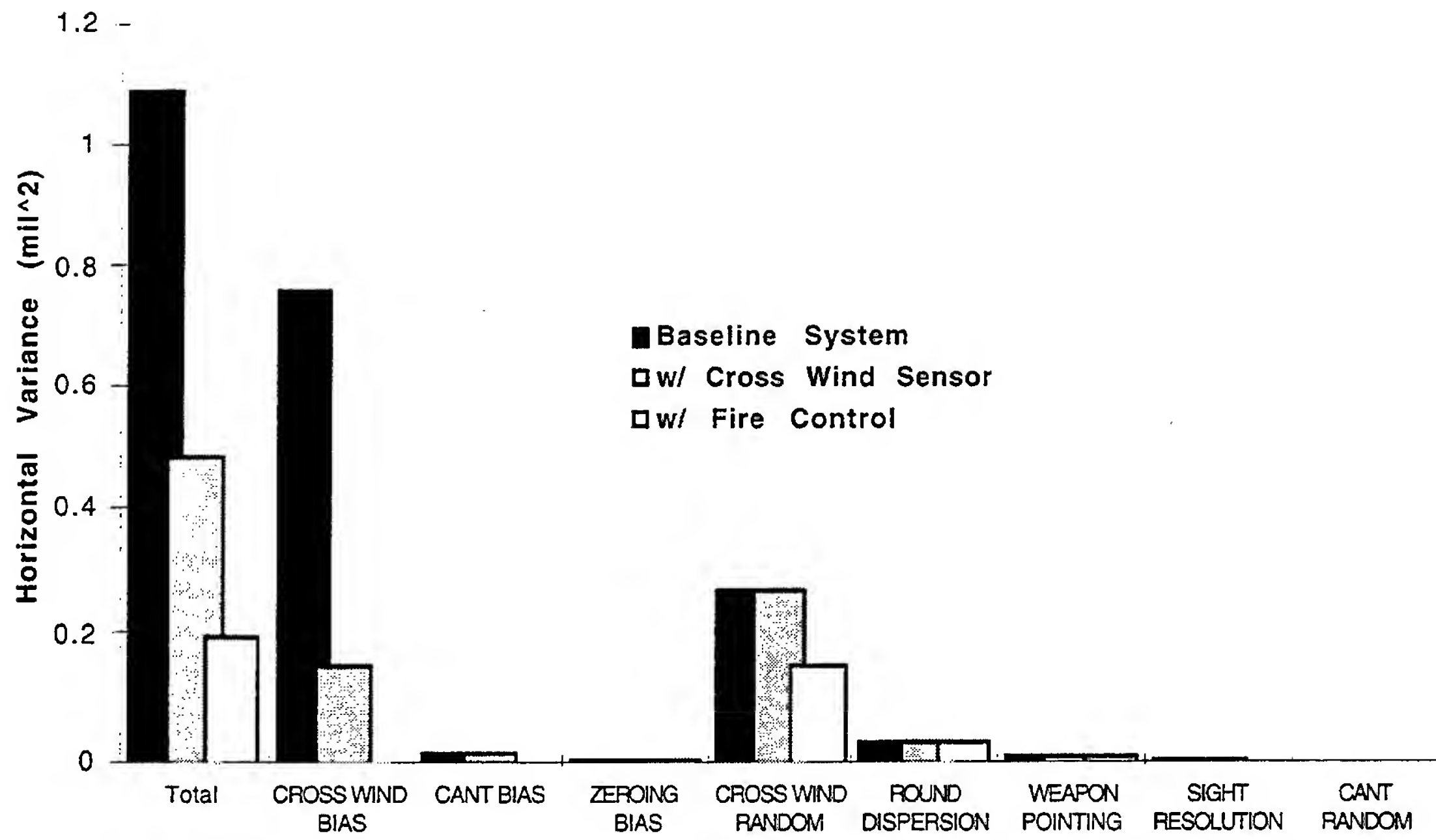

Figure 6. Horizontal Variances, 300 WM, 700 m.

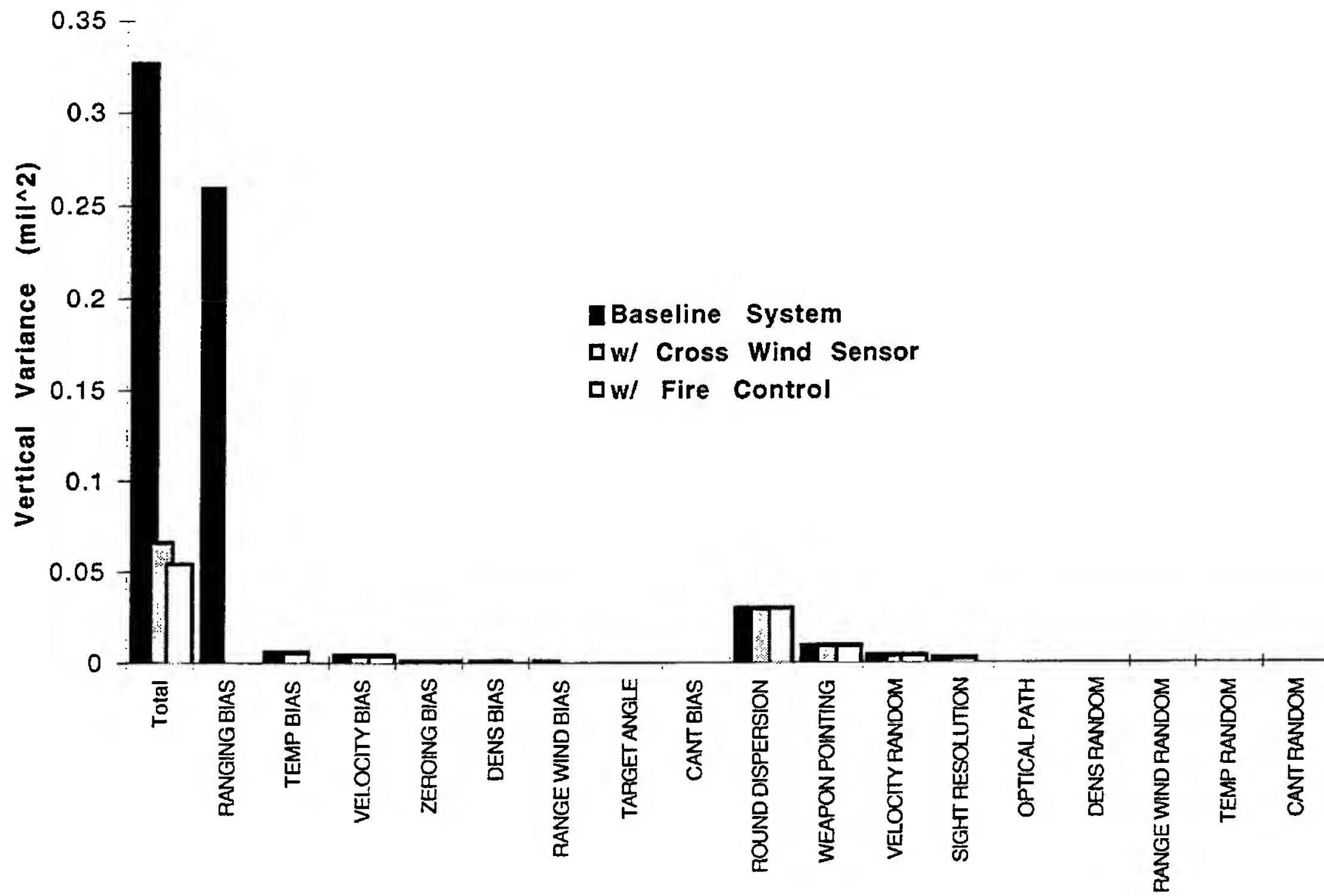

Figure 7. Vertical Variances, 300 WM, 700 m.



To understand the effect that application of fire control has on the error budget, consider Figures 8, 9, and 10. In these figures, horizontal and vertical  $\pm 1$  sigma error values are represented as ellipses. An E-silhouette target is included for a sense of scale. Figure 8 shows the variable bias error for each fire control system. It can be seen that the addition of a crosswind sensor and more accurate range finder greatly reduces the bias error, compared to the baseline system, and, when incorporated as part of a complete, real-time, fire control system, the bias error is significantly reduced further. Figure 9 shows the random error for each system. Note that the random errors for both the baseline and crosswind systems (outer ellipse) are the same because the crosswind system makes no correction for random errors. However, as defined for this analysis, the fire control system cannot correct for very many of the random errors identified, such as round-to-round dispersion and muzzle velocity variation. The result is that many of the random error sources remain, even with the application of fire control (inner ellipse).

Figure 10 shows the total system error for each level of fire control. For the complete fire control system, it can be seen, when compared to Figure 9, that most of the total error is attributable to the remaining random errors. For this combination of error budget, range, and target, the fire control system results in a nearly three-fold increase in the probability of hit over the baseline system. Whether this is an acceptable PH value is open to interpretation. Also shown on Figure 10 is the RRD error used for this ammunition at this range. Notice that the RRD is a significant portion of the remaining error after the application of fire control, which can have little or no control over RRD. Even with fire control applied to existing, fielded weapons, the RRD of the ammunition becomes a limiting factor. This indicates that in order to achieve the types of PHs sought by the user community, both a fire control system and a more accurate weapon-ammunition system will require development.

Certain assumptions have been made about the ability of a shooter to determine range (5% of target range) and crosswind (5-mph sigma from occasion to occasion). In order to examine the effect on PH if other values are used, a sensitivity analysis was performed in which the error source of interest was varied while all others were held constant. Also, since some of the error sources did not have well-defined values, three specific parameters (weapon-target altitude, weapon cant, and zeroing error attributable to zeroing at one range versus another) were varied as follows on page 27.

-----Baseline System  
-----Cross Wind Sensor  
——Fire Control

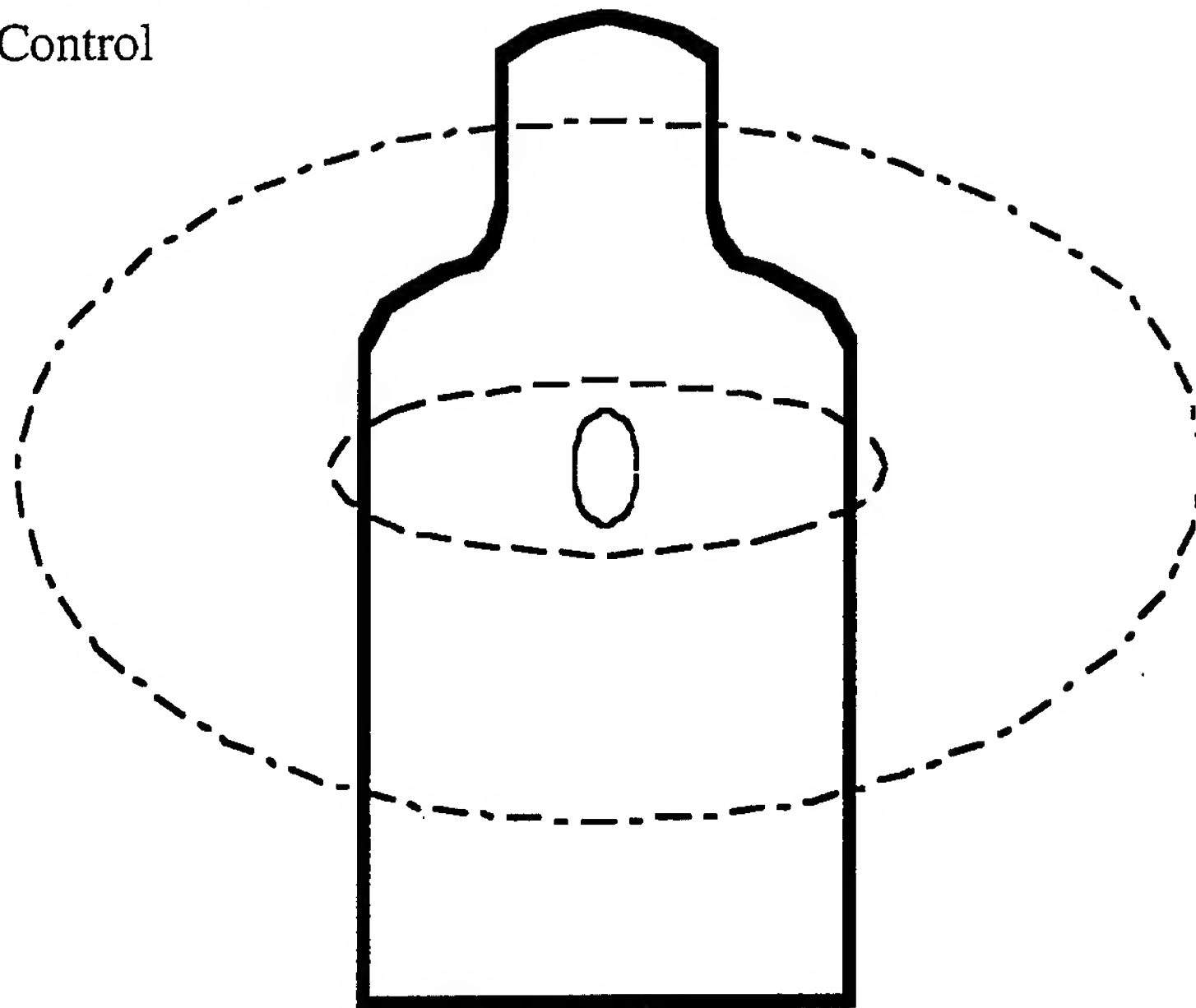

Figure 8. Bias Errors, .300 WM, 700 m.

-----Baseline System  
-----Cross Wind Sensor  
——Fire Control

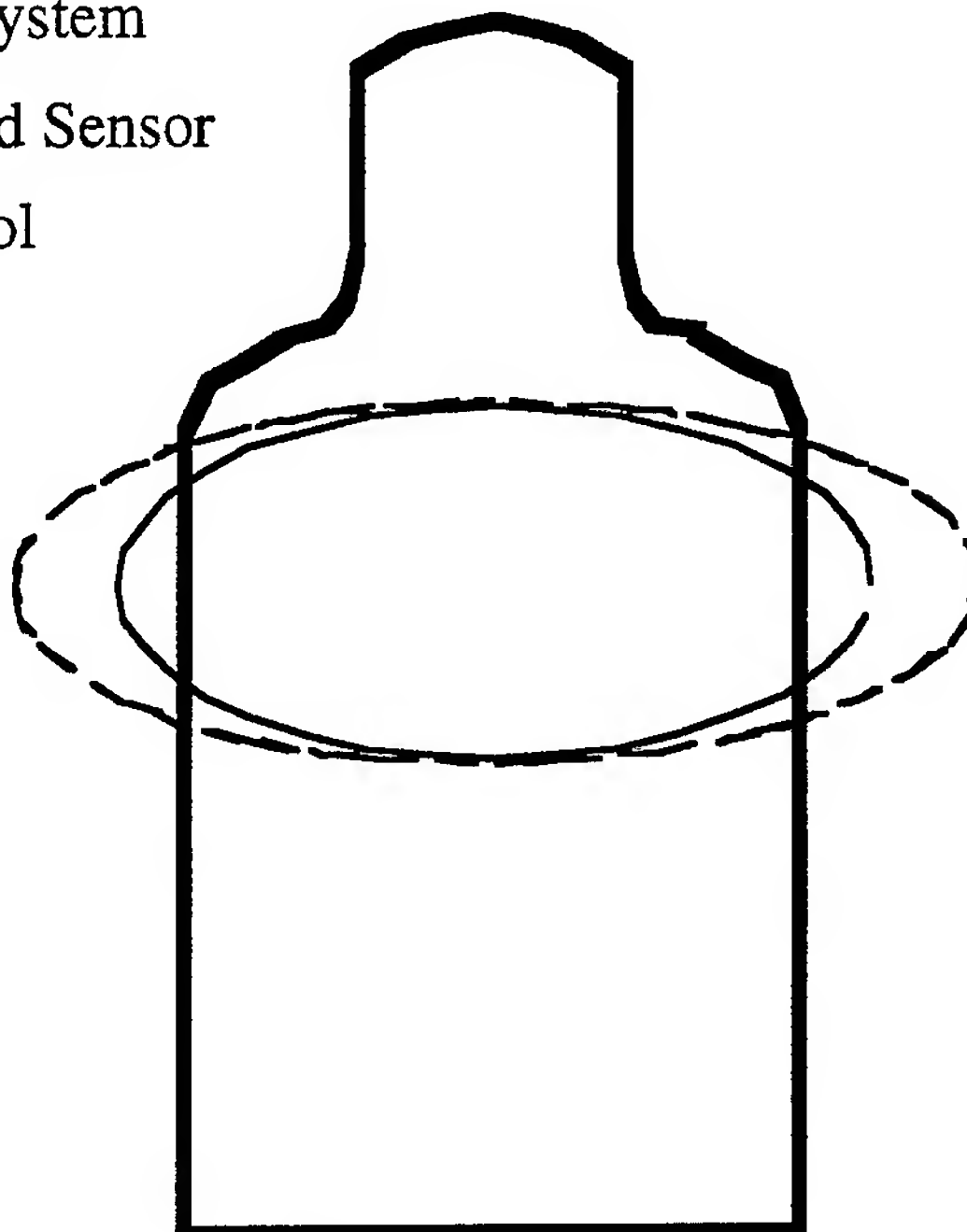

Figure 9. Random Errors, .300 WM, 700 m.



- Baseline System, PH=.20
- w/ CW, PH=.39
- Total Sigma Error w/ FC, PH=.58
- RRD Error only, PH=.96

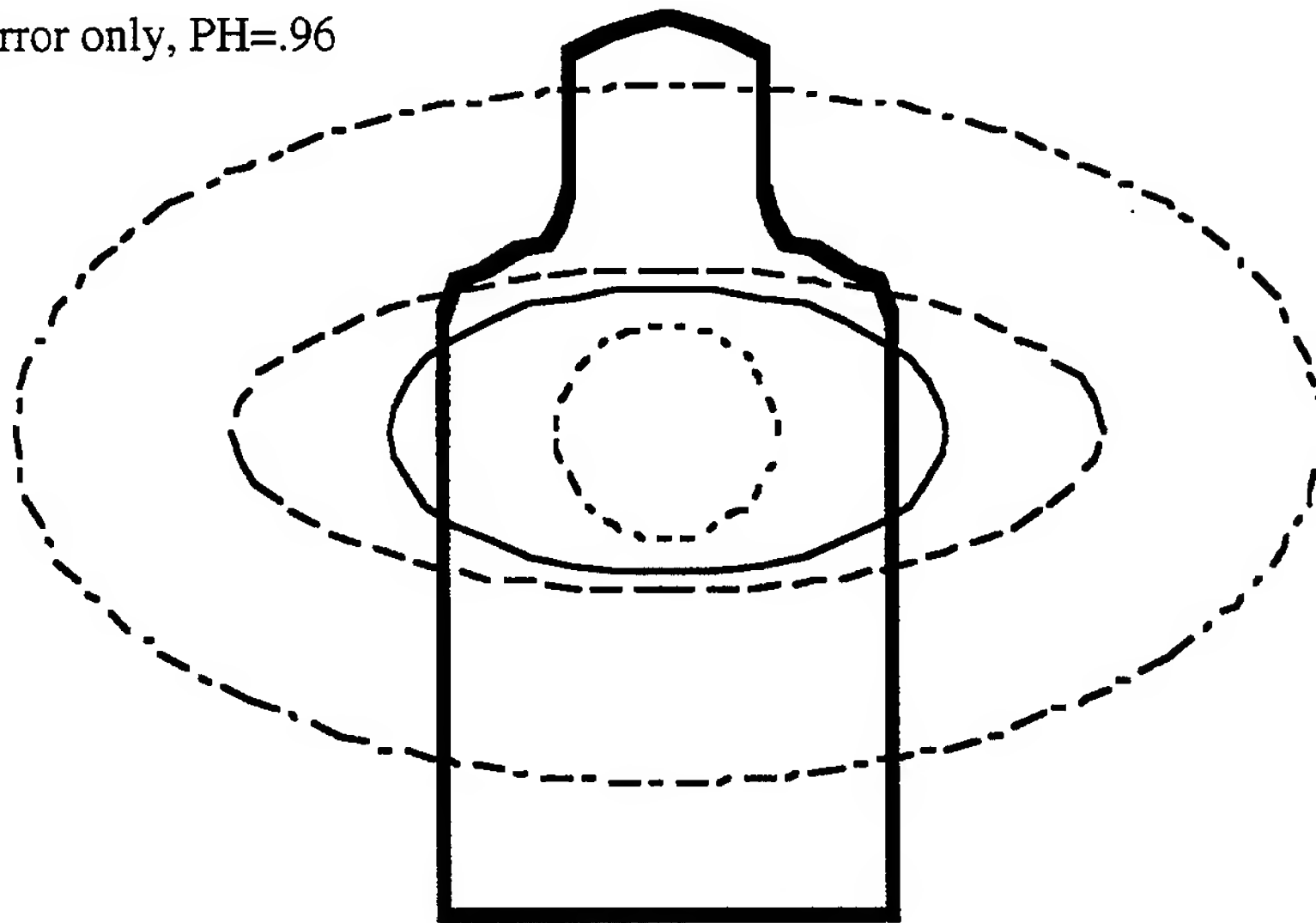

Figure 10. Total Errors. .300 WM, 700 m.

- Weapon-target altitude: 0°, 2°, 5°, 10°, 15°, 20°, 25°, and 30°
- Weapon cant: 0°, 1°, 3°, 5°, and 10°
- Zeroing: 100 and 300 meters

The weapon-ammunition combination selected was the M24 SWS/300 WM, and the fire control concept selected was the baseline. The ranges of engagement selected were 400, 700, 1200, and 1500 meters. Crosswind and ranging error budget sensitivities are shown in Figures 11 and 12. Sensitivities of the other error sources are shown in Appendix D.

Figure 11 shows that for the longer ranges (1200 and 1500 m), the PH is so low that for this weapon-ammunition combination, even with no crosswind error, there is no practical improvement in PH. The same can be said for range error, as seen in Figure 12. For the more common engagement range of 400 m, the PH for a 5-mph crosswind error, i.e., 0.75, increases to 0.95 for no crosswind error. At 400 m, there is little variation in PH versus ranging error. At the current practical limit to sniping engagements (700 m), PH changes from roughly 0.20 for a 5-mph sigma to 0.35 for no crosswind error. PH changes from 0.20 with a 5% ranging error to 0.27 for no ranging error.

### 300 WINMAG, Baseline System

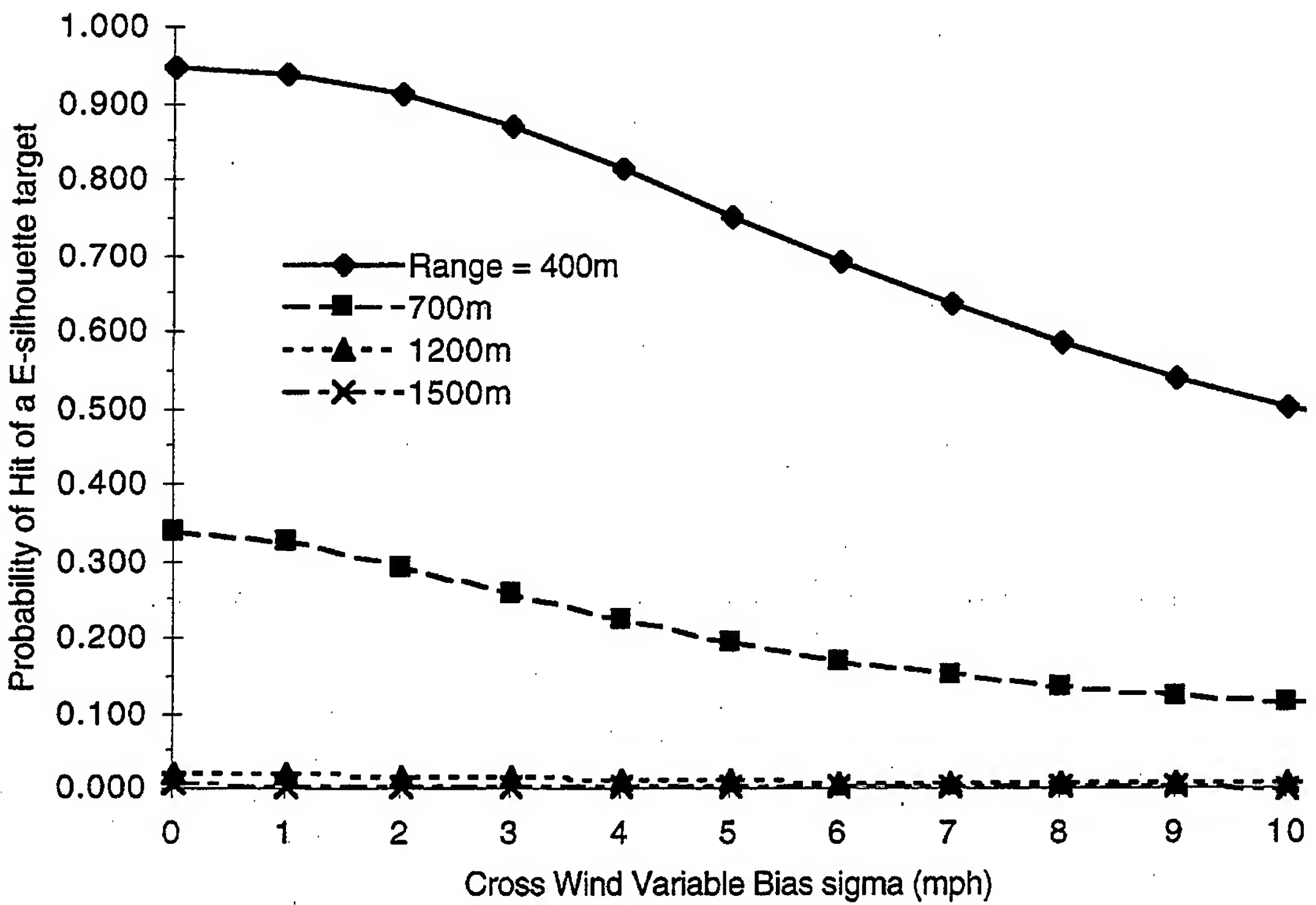
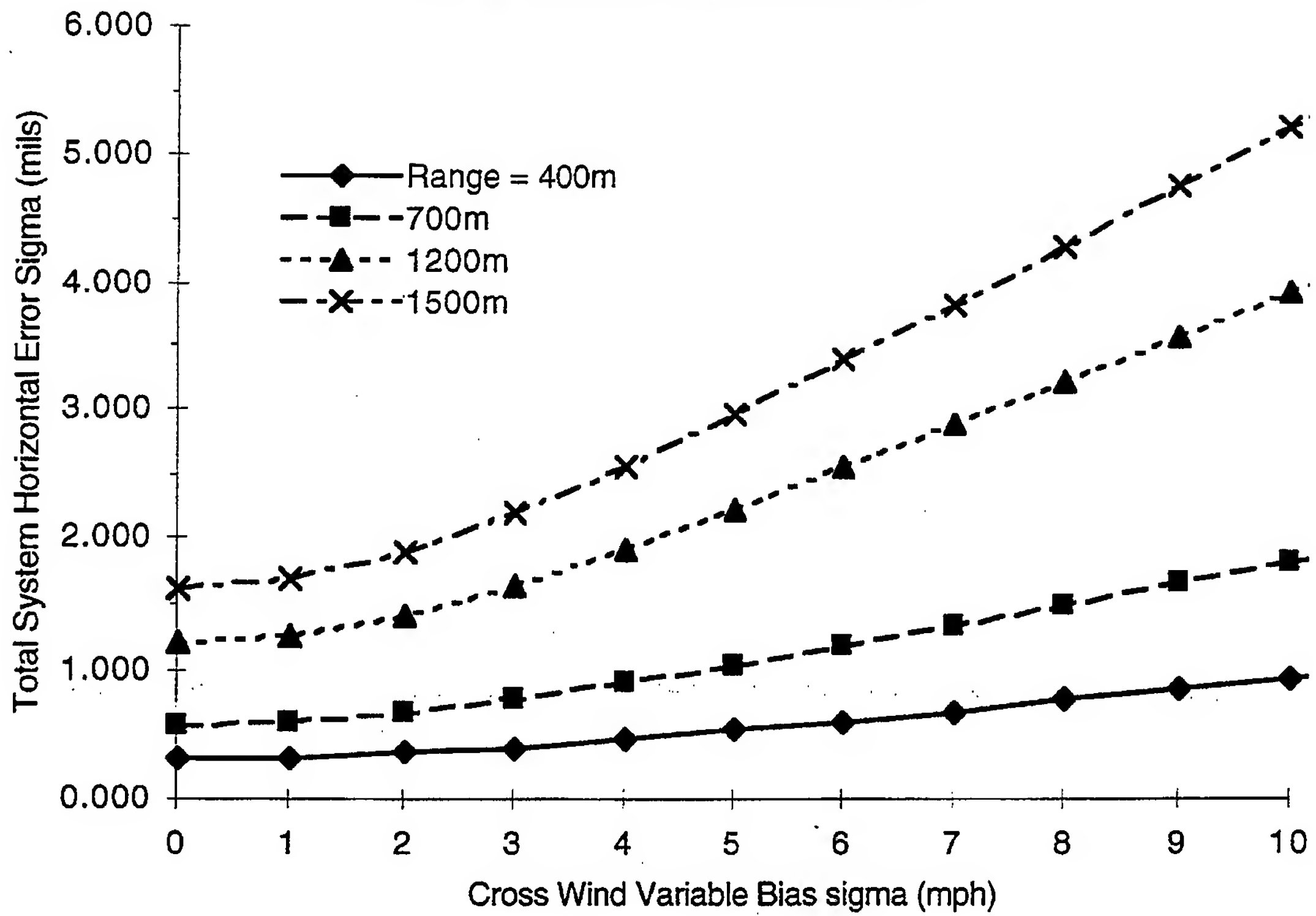

Figure 11. Error Budget Sensitivity, Crosswind Variable Bias.

### 300 WINMAG, Baseline System

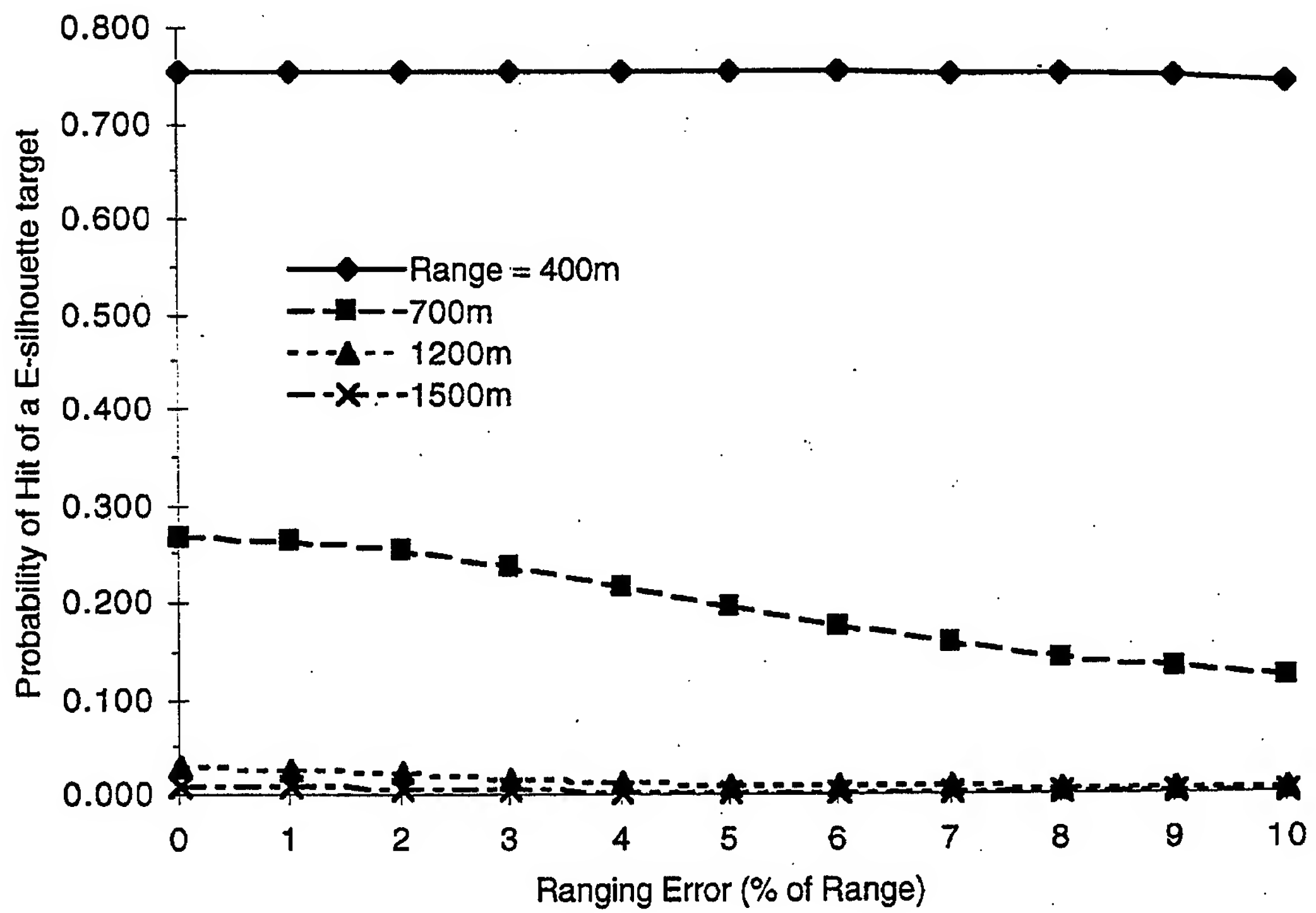
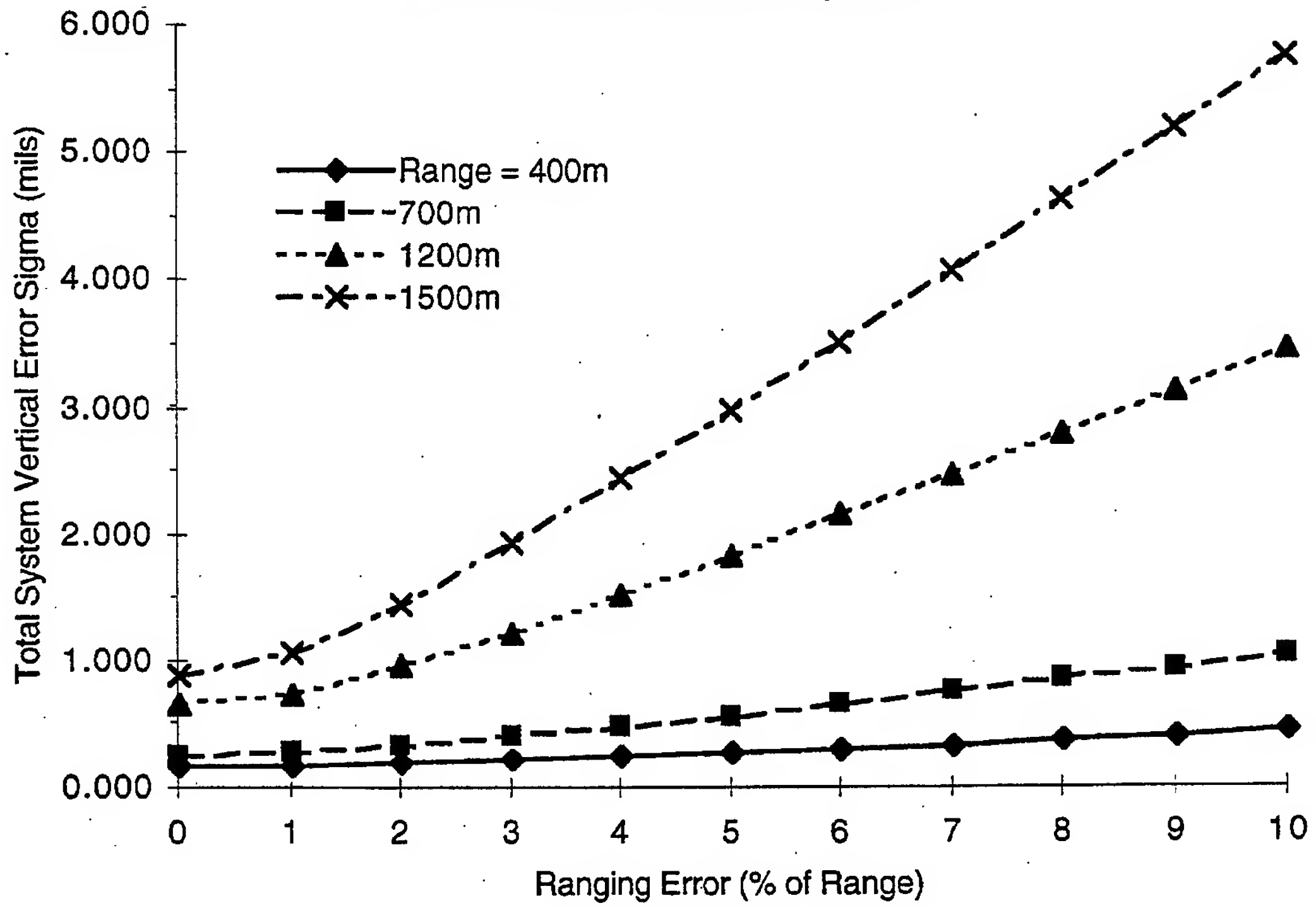

Figure 12. Error Budget Sensitivity, Ranging Error.

## 5. CONCLUSIONS

Snipers are a remarkable breed. Given the multitude of factors that can cause a bullet to miss its intended target, some of which this report has attempted to quantify, it is a wonder that shooters are consistently able to hit anything, especially at extended ranges. Humans are, of course, the ultimate fire control system. Science will never supplant a trained shooter. Technology can only augment the skills that they already possess. However, necessary bravado aside, snipers tend to only remember that one remarkable shot in combat at 800 m. They overlook the number of rounds it takes to zero a weapon or to “walk” that competition-winning group onto a target at the firing range. They attribute any “flyer” in a group to fate. When pressed, however, they acknowledge that they could use some help reaching those long-distance targets.

Not surprisingly, this analysis showed range and crosswind to be two large error sources. A device that could account for those factors would go a long way in improving first-round hit probability. As shown for the 300 WM round against a human-sized target at 700 m, given the assumed firing conditions, a stand-alone crosswind sensor would double the PH of a standard rifle, while a complete fire control system would triple it. Even after correcting for as many error sources as practical, however, it becomes apparent that the inherent inaccuracy of the bullets at those ranges becomes the dominating factor. The most effective fire control system needs to be combined with an ultra-accurate rifle-ammunition system.

As long as bullets are being hurled down range at supersonic speeds, the science of ballistics will govern where it lands. Just as optical scopes were an improvement over iron sights and range finders removed some of the guesswork from range estimation, the fire control proposed in this report will aid the sniper in determining that all-important ballistic correction. It is only fitting to strive to provide snipers with the best tools available so that they can do their job as well as possible and thus survive to shoot another day.

## REFERENCES

1. ARL News Release. "Inertial Reticle System." [web page] [http://www.arl.mil/EA/news\\_releases/sniper.html](http://www.arl.mil/EA/news_releases/sniper.html). August 1995 [Accessed 1 April 1998].
2. Von Wahlde, R., M. Kregel, B.T. Haug, and T. Brosseau, "Application of an Inertial Reticle System to an Objective Personal Weapon," ARL-MR-289, U.S. Army Research Laboratory, Aberdeen Proving Ground, MD, February 1996.
3. Metz, D., D. Sloop, W. Willoughby, L. Nutsch, W. Walter, and R. Von Wahlde, "Evaluation and Assessment of Project White Feather Impact on Sniper Operations (U)," EAI Corporation, 12 June 1998 (SECRET-NOFORN-WNINTEL).
4. Special Operations Working Group, "Special Operations Target Vulnerability and Weaponing Manual (U)," 61 JTCG/ME-83-9, Joint Technical Coordinating Group for Munitions Effectiveness, 1 April 1994 (SECRET-NOFORN-WNINTEL).
5. Haddigan W., "Small Arms (OSW)." [web page] <http://www.benning.army.mil/dcd/sad.htm>. December 1997 [Accessed 24 April 1999].
6. Ewing, M. "U.S. Army M24 Sniper Weapon System." [web page] <http://www.imt.net/~mele/m24.htm>. January 1998 [Accessed 1 April 1998].
7. Reed, D. R., "Sniper Country: Compendium of Terminology." [web page] [http://www.snipercountry.com/Comp\\_M.htm](http://www.snipercountry.com/Comp_M.htm). 1999 [accessed 2 February 1999].
8. Director US TACOM-ACALA. "M24 Sniper Rifle." [web page] <http://www-acala1.ria.army.mil/acala/sma/asi/sam24rif.jpg>. February 1998 [Accessed 1 April 1998].
9. Barrett Firearms Manufacturing, Inc. "M82A1." [web page] <http://www.shooters.com/barrett/82.html>. September 1997 [Accessed 1 April 1998].
10. US Marine Corps, "M82A1A .50 Caliber SASR." [web page] <http://www.hqmc.usmc.mil/factfile.nsf/AVE?openview&count=3000>. June 1996 [Accessed 1 April 1998].
11. Copyright 1997© Barrett Firearms Mfg., Inc. "M82A1." [web page] <http://www.shooters.com/barrett/images/82.jpg>. September 1997 [Accessed 1 April 1998].
12. Thompson L., The Resister Volume II Issue 1. [web page] [http://www3.10pht.com/~oblivion/resister/resister\\_5.html](http://www3.10pht.com/~oblivion/resister/resister_5.html). Summer 1995 [Accessed 2 April 1998].
13. Winchester/Olin Corporation, "Small Calibre Ammunition." [web page] <http://www.army-technology.com/contractors/ammunition/winchester/index.html>. March 1998 [Accessed 2 April 1998].

14. "Jane's Infantry Weapons 1996-97," Twenty-second Edition, Edited by Terry J. Gander, Jane's Information Group Inc., 1996.
15. Karwan, C., "The SR-25," Combat Arms, pp 4-9, 1994.
16. Owner's Manual for Stoner Rifle SR-25 (Including the SR-25 Match Rifle), .308 Winchester Caliber (7.62 x 51 mm NATO) Rifle System, Knight's Manufacturing Company, Vero Beach, FL, March 1996.
17. Plaster, J.L., "Surgical Precision," Guns & Ammunition, pp 64, March 1997.
18. McCoy R., "Caliber .338 Cartridges for Use in the Advanced Medium Sniper Weapon System," FTB-IR-3, US Army Armament Research, Development and Engineering Center, Firing Tables Branch, Aberdeen Proving Ground, MD, September 1993.
19. Frey, D. D., "Virtual Maching—CNC Crankpin Grinding," <http://design.mit.edu/ddfrey/projects/Crank/animated.htm>.
20. McCoy R., "A Parametric Study of the Long Range, Special Applications Sniper Rifle," BRL-MR-3558, US Army Ballistic Research Laboratory, Aberdeen Proving Ground, MD, December 1986.
21. Groves, A., "Method for Computing the First-Round Hit Probability for an Antitank Weapon With Spotting Rifle Control," BRL-MR-1450, Ballistic Research Laboratories, Aberdeen Proving Ground, MD, January 1963.
22. Gilbert, A. Sniper: The Skills, the Weapons, and the Experiences. New York: St. Martin's Paperbacks, 1994.
23. United States Army. John F. Kennedy Warfare Center and School. Special Operations Sniper Training and Employment Handbook. Fort Bragg, NC: Department of the Army, February 1988.
24. United States Army. John F. Kennedy Warfare Center and School. Correcting for Environmental Factors Summary Sheet. Fort Bragg, NC: Department of the Army, January 1986.
25. Contraves, SACMFCS presentation to Crew Served Weapon System Technology Assessment Panel, Picatinny Arsenal. August 6, 1992.
26. Honeywell Inc., Micro Switch Division. "Mass Airflow Sensor." [web page] <http://www.honeywell.com/sensing/prodinfo/massairflow/default.asp>. August 1997 [Accessed 2 April 1998].
27. Harkless, L., Contraves/Bradsher Systems. Private Conversation, re. . Small Arms Common Module Fire Control System, April 1 1998.



28. Gatt, P., et al., "Eye-safe Solid State Laser Crosswind Sensor," CTI-TR-9709, Coherent Technologies, Inc., Boulder, CO, May 1997.
29. Wang, T., and C. Hsu, "A Crosswind Sensor Using Optical Scintillation of a Laser Illuminated Target", Phase I SBIR Final Report, Scientific Technology, Inc., Gaithersburg, MD, May 1997.
30. Rogers, P., "Low Cost Eye-Safe Miniaturized Laser Crosswind Sensor," Phase I SBIR Final Technical Report, Optical Air Data Systems, L.P., West Bethesda, MD, August 1997.
31. Torre, J.P., S. Wansack, et al., "Laser Range finder Accuracy Investigation," Draft Report, U.S. Army Research Laboratory, Aberdeen Proving Ground, MD, March 1994.
32. Weaver, J.M., "System Error Budgets, Target Distributions and Hitting Performance Estimates for General-Purpose Rifles and Sniper Rifles of 7.62 x 51 mm and Larger Calibers," AMSAA-TR-461, US Army Materiel Systems Analysis Activity, Aberdeen Proving Ground, MD, May 1990.
33. Pflieger, K.P., "Accuracy Performance Comparison for Selected Sniper Weapon Systems," Draft Report, U.S. Army Armament Research, Development, and Engineering Center, Picatinny Arsenal, NJ, 1996.
34. Federal Cartridge Company - 1998 Ammunition Catalog - Gold Medal Centerfire Rifle. [web page] 1998; <http://www.federalcartridge.com/a05p03.html>. [Accessed 1 February 1999].
35. 300 Winchester Magnum: AERODYNAMICS: .308 CAL 190 GR SIERRA FMJ. small\_arms-1.aero. Computer database. Firing Tables Branch, ARDEC element at APG MD, 1998. BALLISTICS: .308 CAL 190 GR SIERRA FMJ. small\_arms-1.bal. Computer database. Firing Tables Branch, ARDEC element at APG MD, 1998.
36. 50 CAL MK211: AERODYNAMICS: CAL.50/MK211/BARRETT82A1/JUN 92. mk211.aero2. Computer database. Firing Tables Branch, ARDEC element at APG MD, 1998. BALLISTICS: .50 CAL MK211 MP (modified by RVW 10 Sept 97). mk211bal3. Computer database. Firing Tables Branch, ARDEC element at APG MD, 1998.
37. 7.62MM M118 BALL: AERODYNAMICS: 7.62MM M118 BALL. small\_arms-1.aero. Computer database. Firing Tables Branch, ARDEC element at APG MD, 1998. BALLISTICS: 7.62MM M118 BALL. small\_arms-1.bal. Computer database. Firing Tables Branch, ARDEC element at APG MD, 1998.
38. Bain. The Shot Show - 1997. [web page] Jan 1997; [http://www.snipercountry.com/SHOT\\_show\\_1997.html](http://www.snipercountry.com/SHOT_show_1997.html). [Accessed 30 March 1998].
39. U.S. Marine Corps, Weapons Training Battalion, Test and Evaluation Facility, "Lake City M118LR Ammunition Test Data", 4 Mar 1996.
40. General Trajectory Program (GTRAJ). V5.11. Computer software. Firing Tables Branch, ARDEC element at APG MD, 1998. FORTRAN code.

41. General Trajectory Program for Unit Effects (gtrajuf). Computer software. Firing Tables Branch, ARDEC element at APG MD, 1998. Fortran code.
42. McCoy R., et al., "Caliber .50 Ammunition for Training Use in the Barrett Model 82A1 Sniper Rifle," ARFSD-TR-93043, U.S. Army Armament Research, Development, and Engineering Center, Picatinny Arsenal, NJ, May 1994.
43. Grubbs F., "Statistical Measures of Accuracy for Riflemen and Missile Engineers," Copyrighted 1964 by Frank E. Grubbs Ph.D., Havre de Grace, MD.



APPENDIX A  
AEROBALLISTIC, TRAJECTORY, AND UNIT EFFECTS DATA

INTENTIONALLY LEFT BLANK

## AEROBALLISTIC, TRAJECTORY, AND UNIT EFFECTS DATA

### A.1 Aerodynamics and Ballistics Data

#### A.1.1 300 Winchester Magnum

Federal Cartridge Company makes a 300 Winchester magnum, the GM300WM, that uses a 190-grain, Sierra MKBTHP bullet fired at 2,900 fps.[34] These data are listed in Table A-1. Aerodynamics and ballistics data for the 300 Winchester magnum were based on a small arms database created by the Firing Tables Branch, an ARDEC element at Aberdeen Proving Ground, Maryland, for a similar Sierra 190-grain bullet.[35] The drag coefficients (CDs) and ballistic inputs are listed in Tables A-2 and A-3. The resulting trajectory data in Table A-12 agree reasonably well with Table A-1.

Table A-1. Velocity Data, Federal GM300WM, 300 Win. Mag. Sierra MKBTHP [34]

Range (yd)	Velocity (fps)	Energy (foot-pounds)	Wind Drift (in) at 10 mph	TOF <sup>a</sup> (sec) calculated	Trajectory (in) <sup>b</sup>
0	2900	3550	0	0.000	
100	2730	3135	0.6	0.107	12.9
200	2560	2760	2.4	0.221	22.5
300	2400	2420	5.5	0.342	26.9
400	2240	2115	10.1	0.471	25.1
500	2090	1840	16.4	0.610	16.4
600	1940	1595	24.2	0.758	0
700	1810	1375	34.2	0.918	-25.8
800	1680	1185	46.6	1.092	-63.0
900	1550	1015	61.1	1.278	-112.2
1000	1440	870	78.0	1.478	-175.6

<sup>a</sup>TOF = time of flight  
<sup>b</sup>Height of bullet trajectory in inches above or below line of sight if zeroed at 600 yards. Sights 1.5 inches above bore line

Table A-2. Drag Coefficient (CD) for .300 Winchester Magnum [35]

Mach	CD	Mach	CD	Mach	CD	Mach	CD
0	0.135	1	0.404	1.3	0.399	1.8	0.355
0.86	0.135	1.04	0.42	1.4	0.388	2	0.34
0.9	0.14	1.08	0.423	1.5	0.378	2.2	0.329
0.94	0.15	1.1	0.423	1.6	0.369	2.5	0.315
0.98	0.36	1.2	0.411	1.7	0.36	3	0.297

Table A-3. Ballistic Inputs for .300 Winchester Magnum

Standard Weight	0.027143 (lb) (190 grains)	[35]
Projectile Diameter	7.82 mm (0.308 inch)	[35]
Axial Moment of Inertia	1.90E-06 (lb/ft <sup>2</sup> )	[35]
Ballistic Coefficient (weight/dia <sup>2</sup> )	0.2861 (lb/in <sup>2</sup> )	[35]
Muzzle Velocity	884 (m/s) (2,900 ft/s)	[34]

### A.1.2 50-Caliber MK211

Aerodynamics and ballistics data for the 50-Caliber MK211 ammunition were based on a small arms database created by the Firing Tables Branch.[36] The CD's and ballistic inputs are listed in Tables A-4 and A-5.

Table A-4. Drag Coefficient (CD) for .50 CAL MK211 [36]

Mach	CD	Mach	CD	Mach	CD	Mach	CD
0	0.107	0.874	0.124	1.12	0.377	1.92	0.338
0.724	0.107	0.923	0.155	1.17	0.381	2.12	0.326
0.774	0.109	0.971	0.231	1.22	0.381	2.36	0.315
0.824	0.112	1.04	0.35	1.42	0.37	2.8	0.3
0.85	0.116	1.07	0.365	1.72	0.351	3	0.295

Table A-5. Ballistic Inputs .50 CAL MK211

Standard Weight	0.09577 (lb) (670 grains)	[36]
Projectile Diameter	12.95 mm	[36]
Axial Moment of Inertia	2.050E-05 (lb/ft <sup>2</sup> )	[36]
Ballistic Coefficient (weight/dia <sup>2</sup> )	0.3684 (lb/in <sup>2</sup> )	[36]
Muzzle Velocity	827.53 (m/s) (2,715 ft/s)	[36]

### A.1.3 M118 Long Range

Lacking aeroballistic data for the 175-grain M118 long range ammunition, the drag coefficient for the 7.62-mm M118 BALL [37] was modified in order to match velocity versus range and crosswind deflection versus range data (from which time of flight [TOF] can be derived) for the Federal GM308M2. The GM308M2 is a new load for Federal's Gold Medal center-fire rifle line that uses a 175-grain, .308 Sierra MatchKing<sup>®</sup> BTHP bullet.[34] This new

match round is reported to be substantially the same round as the M118LR sniper and match round that the military is using.[38] The M118LR is comprised of a 175-grain MatchKing® bullet in Lake City brass. The data for the GM308M2 are listed in Table A-6. Also included are data for the 168-grain, Federal GM308M. The resulting drag coefficient for the M118LR compared with the M118 BALL is listed in Table A-7. All the other aerodynamic coefficients for the M118 BALL [37] were used for the M118LR. The ballistic inputs used for the M118LR are listed in Table A-8.

After this analysis, the author received ammunition test data for the Lake City M118LR.[39] Time did not permit an extensive examination of these data for inclusion in this report. A cursory look noted the mean and standard deviation muzzle velocity to be  $820 \pm 4$  m/s ( $2690 \pm 12$  fps) for 30 rounds. The charge was 44 grains of WC750 powder. This is slightly faster than what was used here. It was also observed that the measured down-range velocities differed from the apparently computed ones reported by Federal Cartridge Company. These are compared in Table A-9. Evidently, the M118LR does not retain its velocity as well as presumed. Thus, it will be more sensitive to the error sources used in this report.

Table A-6. Velocity Data, Federal GM308M2 and GM308M [34]

Range (yd)	Velocity (fps) (to nearest 10 fps)		Energy (foot-pounds) (to nearest 5 ft-lb.)		Wind Drift (in) at 10 mph		TOF (sec) calculated	
	175 grain GM308M2	168 grain GM308M	175 grain GM308M2	168 grain GM308M	175 grain GM308M2	168 grain GM308M	175 grain GM308M2	168 grain GM308M
0	2600	2600	2625	2520	0	0	0.000	0.000
100	2420	2410	2285	2170	0.6	0.7	0.119	0.119
200	2260	2230	1975	1855	3	3.2	0.248	0.249
300	2090	2060	1705	1580	7	7.6	0.386	0.389
400	1940	1890	1460	1340	12.7	13.8	0.534	0.540
500	1790	1740	1245	1130	20.8	22.8	0.695	0.706
600	1650	1590	1060	970	31.4	34.3	0.871	0.887
700	1520	1460	900	795	44.3	48.4	1.059	1.083
800	1400	1340	765	670	60.1	66.1	1.265	1.299
900	1300	1230	650	565	79.1	86.9	1.488	1.532
1000	1200	1150	560	490	101	111	1.728	1.785

Table A-7. Drag Coefficient (CD) Used for M118 LR

M	CD M118 BALL	CD M118LR	M	CD M118 BALL	CD M118LR
0	0.133	0.1	1.15	0.417	0.348
0.8	0.133	0.1	1.2	0.413	0.348
0.85	0.137	0.105	1.3	0.396	0.341
0.9	0.149	0.116	1.4	0.38	0.336
0.92	0.16	0.126	1.6	0.355	0.329
0.95	0.19	0.151	1.8	0.338	0.322
1	0.369	0.298	2	0.325	0.312
1.02	0.389	0.316	2.2	0.316	0.303
1.06	0.407	0.334	2.5	0.308	0.298
1.1	0.416	0.345	3	0.3	0.29

Table A-8. Ballistic Inputs M118LR

Standard Weight	0.025 (lb) (175 grains)	[34]
Projectile Diameter	7.82 mm (0.308 inch)	[34]
Axial Moment of Inertia	1.70E-05 (lb/ft <sup>2</sup> )	[34]
Ballistic Coefficient (weight/dia <sup>2</sup> )	0.2635 (lb/in <sup>2</sup> )	calculated
Muzzle Velocity	792.48 (m/s) (2,600 ft/s)	[34]

Table A-9. Velocity Comparison Between Federal GM308M2 and M118LR

Range (yd.)	Velocity (fps)	
	GM308M2	M118LR
0	2600	2690 (15 ft from muzzle)
600	1650	1534
1000	1200	933

#### A.1.4 300-Grain .338-.416

Aeroballistic data for the 300-grain, .338-.416 were derived from accuracy firing tests. A predicted drag curve was modified to match the bullet velocity profiles as measured via radar, Table A-10. The ballistic inputs used for the .338-.416 are listed in Table A-11.[18]



Table A-10. Drag Coefficient (CD) for .338-.416

Mach	CD	Mach	CD	Mach	CD	Mach	CD	Mach	CD
0	0.147	0.95	0.193	1.2	0.378	2	0.305	2.6	0.26
0.8	0.147	1	0.35	1.3	0.37	2.2	0.29	2.7	0.253
0.85	0.148	1.02	0.369	1.4	0.359	2.3	0.282	3	0.235
0.9	0.151	1.05	0.378	1.6	0.339	2.4	0.274	3.5	0.211
0.925	0.163	1.1	0.381	1.8	0.321	2.5	0.266		

Table A-11. Ballistic Inputs .338-.416

Standard Weight	0.043 (lb) (300 grains)	[18]
Projectile Diameter	8.59 mm (0.338 inch)	[18]
Axial Moment of Inertia	1.70E-05 (lb./ft <sup>2</sup> )	assumed
Ballistic Coefficient (weight/dia <sup>2</sup> )	0.375 (lb./in <sup>2</sup> )	calculated
Muzzle Velocity	927.4 (m/s) (3,040 ft/s)	Firing Tests

#### A.2 Trajectory and Unit Effects Data

Tables A-12, A-13, A-14, and A-15 contain trajectory data, and A-16, A-17, A-18, and A-19 contain unit effects for the .300 WM, .50 cal MK211, M118LR, and .338-.416, respectively. Trajectory data were obtained from the General Trajectory Program (GTRAJ) [40] and unit effects from the GTRAJ for Unit Effects (GTRAJUF).[41]

Table A-12. Trajectory Data for the .300 Winchester Magnum

Range (m)	Velocity (m/s)	Mach Number	Height (m)	Time (sec)	Super Elevation (SE) (mil)
0	884	2.59775	0	0	0
100	819.789	2.40913	2.54	0.11752	0.6727
200	758.745	2.2298	4.934	0.24437	1.4172
300	700.808	2.05958	7.157	0.38156	2.2448
400	645.797	1.89796	9.18	0.53025	3.1681
500	593.508	1.74432	10.967	0.69183	4.2021
600	544.199	1.59943	12.475	0.86783	5.3651
700	497.514	1.46224	13.651	1.06006	6.679
800	453.416	1.33264	14.43	1.27064	8.1703
900	411.855	1.21049	14.73	1.50209	9.8717
1000	372.859	1.09588	14.45	1.75733	11.8239
1100	337.701	0.99253	13.462	2.03947	14.0766
1200	318.309	0.93552	11.618	2.34625	16.6809
1300	307.567	0.90392	8.807	2.66608	19.6419
1400	297.654	0.87475	4.958	2.9969	22.9348
1500	288.309	0.84724	0	3.33874	26.5414

Table A-13. Trajectory Data for .50 CAL MK211

Range (m)	Velocity (m/s)	Mach Number	Height (m)	Time (sec)	Super Elevation (SE) (mil)
0	827.53	2.43181	0	0	0
100	780.467	2.29356	2.165	0.12448	0.7592
200	735.272	2.1608	4.17	0.25654	1.5798
300	691.875	2.0333	5.995	0.3968	2.4697
400	650.159	1.91074	7.616	0.54594	3.4368
500	610.11	1.79307	9.007	0.70476	4.49
600	571.743	1.68034	10.135	0.87412	5.6399
700	535.097	1.57265	10.965	1.05496	6.8982
800	500.188	1.47006	11.453	1.2483	8.2785
900	467.027	1.3726	11.55	1.45525	9.7962
1000	435.641	1.28035	11.199	1.67701	11.469
1100	406.028	1.19331	10.332	1.91486	13.3169
1200	378.5	1.11239	8.871	2.17011	15.3625
1300	353.959	1.04023	6.726	2.44366	17.6305
1400	335.021	0.98455	3.8	2.73484	20.1443
1500	321.828	0.94573	0	3.04024	22.9166

Table A-14. Trajectory Data for M118LR

Range (m)	Velocity (m/s)	Mach Number	Height (m)	Time (sec)	Super Elevation (SE) (mil)
0	884	2.59775	0	0	0
100	819.789	2.40913	2.54	0.11752	0.6727
200	758.745	2.2298	4.934	0.24437	1.4172
300	700.808	2.05958	7.157	0.38156	2.2448
400	645.797	1.89796	9.18	0.53025	3.1681
500	593.508	1.74432	10.967	0.69183	4.2021
600	544.199	1.59943	12.475	0.86783	5.3651
700	497.514	1.46224	13.651	1.06006	6.679
800	453.416	1.33264	14.43	1.27064	8.1703
900	411.855	1.21049	14.73	1.50209	9.8717
1000	372.859	1.09588	14.45	1.75733	11.8239
1100	337.701	0.99253	13.462	2.03947	14.0766
1200	318.309	0.93552	11.618	2.34625	16.6809
1300	307.567	0.90392	8.807	2.66608	19.6419
1400	297.654	0.87475	4.958	2.9969	22.9348
1500	288.309	0.84724	0	3.33874	26.5414

Table A-15. Trajectory Data for .338-.416

Range (m)	Velocity (m/s)	Mach Number	Height (m)	Time (sec)	Super Elevation (SE) (mil)
0	927.41	2.72532	0	0	0
100	885.145	2.60116	1.492	0.11039	0.6
200	843.564	2.47901	2.861	0.22614	1.238
300	802.652	2.35881	4.093	0.34769	1.9193
400	762.403	2.24055	5.174	0.47554	2.6483
500	722.959	2.12466	6.088	0.61025	3.4302
600	684.48	2.01159	6.815	0.75243	4.2708
700	647.04	1.90157	7.335	0.90271	5.1766
800	610.685	1.79473	7.622	1.06181	6.1551
900	575.436	1.69114	7.647	1.23052	7.2146
1000	541.318	1.59087	7.376	1.40972	8.3648
1100	508.353	1.49398	6.772	1.60039	9.6168
1200	476.571	1.40056	5.79	1.8036	10.9834
1300	446.004	1.31071	4.376	2.02056	12.4793
1400	416.744	1.22469	2.47	2.2526	14.1215
1500	389.017	1.14318	0	2.50111	15.9296

Table A-16. Unit Effects Data for 300 Win. Mag., 190 gr., fired at 2,900 ft/s

Range (m)	dRange/dSE (m/mil)	Velocity m/(m/s)	Air Temp m/(%)	Density m/(%)	Range Wind m/(m/s)	Crosswind m/(m/s)
0	145.242	0	0	0	0	0
100	132.031	0.0001	0	0	0	0.0044
200	119.529	0.0006	0	0.0003	0	0.018
300	107.825	0.0015	0.0002	0.0011	0.0002	0.0421
400	96.889	0.0029	0.0005	0.0029	0.0005	0.0776
500	86.685	0.0048	0.001	0.0064	0.0011	0.126
600	77.219	0.0075	0.002	0.0124	0.0022	0.1889
700	68.467	0.011	0.0036	0.0222	0.0041	0.2679
800	60.393	0.0156	0.0061	0.0375	0.007	0.3654
900	52.973	0.0216	0.0098	0.0608	0.0117	0.4837
1000	46.198	0.0292	0.0154	0.0956	0.0188	0.6258
1100	40.091	0.039	0.0231	0.1451	0.0296	0.7949
1200	35.096	0.051	0.0301	0.2064	0.0453	0.9885
1300	31.422	0.0643	0.0325	0.2761	0.0664	1.1951
1400	28.598	0.0787	0.0295	0.3552	0.0935	1.4127
1500	26.325	0.0941	0.0207	0.4449	0.1272	1.6412

Table A-17. Unit Effects Data for .50 CAL MK211 fired at 2,715 ft/s

Range (m)	dRange/dSE (m/mil)	Velocity m/(m/s)	Air Temp m/(%)	Density m/(%)	Range Wind m/(m/s)	Crosswind m/(m/s)
0	131.30	0	0	0	0	0
100	121.87	0.0002	0	0	0	0.0036
200	112.75	0.0007	0	0.0003	0	0.0148
300	104.06	0.0018	0.0001	0.0009	0.0002	0.0342
400	95.82	0.0033	0.0004	0.0024	0.0004	0.0624
500	88.09	0.0054	0.0008	0.005	0.0009	0.1004
600	80.67	0.0082	0.0015	0.0095	0.0018	0.1489
700	73.80	0.0119	0.0026	0.0164	0.0031	0.2088
800	67.30	0.0164	0.0042	0.0267	0.0052	0.2813
900	61.26	0.0221	0.0064	0.0416	0.0082	0.3674
1000	55.63	0.029	0.0095	0.0626	0.0127	0.4684
1100	50.39	0.0374	0.0136	0.0913	0.0189	0.5853
1200	45.53	0.0475	0.0189	0.1301	0.0275	0.7197
1300	41.14	0.0596	0.0252	0.1805	0.0394	0.8724
1400	37.29	0.0738	0.0313	0.2424	0.0554	1.0427
1500	34.04	0.0897	0.035	0.3143	0.0762	1.2271

Table A-18. Unit Effects Data for 175 gr. M118LR fired at 2,600 ft/s

Range (m)	dRange/dSE (m/mil)	Velocity m/(m/s)	Air Temp m/(%)	Density m/(%)	Range Wind m/(m/s)	Crosswind m/(m/s)
0	118.971	0	0	0	0	0
100	108.394	0.0002	0	0	0	0.0051
200	98.348	0.0009	0	0.0004	0.0001	0.021
300	88.921	0.0021	0.0002	0.0015	0.0003	0.049
400	80.118	0.004	0.0004	0.0038	0.0008	0.0903
500	71.95	0.0067	0.001	0.0084	0.0017	0.1464
600	64.411	0.0103	0.0019	0.0161	0.0034	0.2188
700	57.481	0.0151	0.0033	0.0285	0.0063	0.3094
800	51.122	0.0214	0.0053	0.0477	0.0108	0.42
900	45.332	0.0293	0.0082	0.0763	0.0177	0.5529
1000	40.182	0.0393	0.0117	0.1162	0.0281	0.7096
1100	35.967	0.0512	0.0133	0.1659	0.043	0.8869
1200	32.775	0.0645	0.0140	0.2232	0.063	1.077
1300	30.31	0.0788	0.0016	0.2882	0.0886	1.2776
1400	28.326	0.0942	0.0135	0.3614	0.1204	1.4877
1500	26.688	0.1107	0.0285	0.4436	0.1591	1.7074



Table A-19. Unit Effects Data for 300 gr. .338-.416 fired at 3,040 ft/s

Range (m)	dRange/dSE (m/mil)	Velocity m/(m/s)	Air Temp m/(%)	Density m/(%)	Range Wind m/(m/s)	Cross Wind m/(m/s)
0	165.298	0	0	0	0	0
100	156.796	0.0001	0	0	0	0.0025
200	148.305	0.0005	0.0001	0.0002	0	0.0105
300	139.99	0.0012	0.0002	0.0006	0.0001	0.0242
400	131.881	0.0023	0.0005	0.0015	0.0002	0.0443
500	123.958	0.0038	0.001	0.0031	0.0004	0.0712
600	116.264	0.0058	0.0019	0.0058	0.0007	0.1057
700	108.805	0.0082	0.0031	0.0099	0.0013	0.1482
800	101.599	0.0114	0.0049	0.0161	0.0021	0.1996
900	94.641	0.0152	0.0074	0.0249	0.0034	0.2607
1000	87.937	0.0198	0.0108	0.0371	0.0052	0.3322
1100	81.501	0.0255	0.0154	0.0538	0.0078	0.4151
1200	75.337	0.0322	0.0213	0.0765	0.0114	0.5106
1300	69.454	0.0402	0.0291	0.1066	0.0163	0.62
1400	63.857	0.0498	0.0391	0.1463	0.023	0.7443
1500	58.565	0.0612	0.0517	0.1982	0.032	0.8851

### A.3 Round-to-Round Dispersion (RRD) Data

#### A.3.1 RRD Data for the M118LR and 300 WM Ammunition

Because data about the M118LR were lacking and with an assumed similarity between ammunition types, the round-to-round dispersion (RRD) data for the M118LR and 300 WM ammunition were based on a fit of dispersion data for the 7.62x51-mm M118 SPECIAL BALL CARTRIDGE ammunition (see Appendix B of Reference 32 and Figure A-1). The test data are for numerous ammunition lots and 10-round groups fired from bolt-action, accuracy (Mann-type) barrels and machine rests at 100 yard ranges as far as 1000 yards. These data compare well with other data cited in Reference 32 (Estimated RRD, Bolt-Action Rifle, Machine Rest, Table 2.2, Part A; Test Data, Table 2.2, Part B; M118 RRD Requirement, Table B-1, Note d). Because the data at 200 yards seemed too high for the trend of the data and because they contained far fewer groups, they were not included in the fit of the data to extrapolate to 1500 m. A parabolic fit of the data was made rather than a linear fit because at about 900 m, the bullet goes subsonic, and it is believed that the dispersion widens greatly after that. Although labeled the intrinsic RRD of the ammunition, the data may contain other possible error sources than RRD, such as velocity variations, wind, etc. The range conditions for each firing occasion are not

described. Nevertheless, as Reference 32 points out, "it is relatively rare to have data identified to specific ammunition lots and to have so many different ranges fired by the same organization under identical test conditions." Therefore, it is felt that these data are most representative of the true RRD for this class of ammunition.

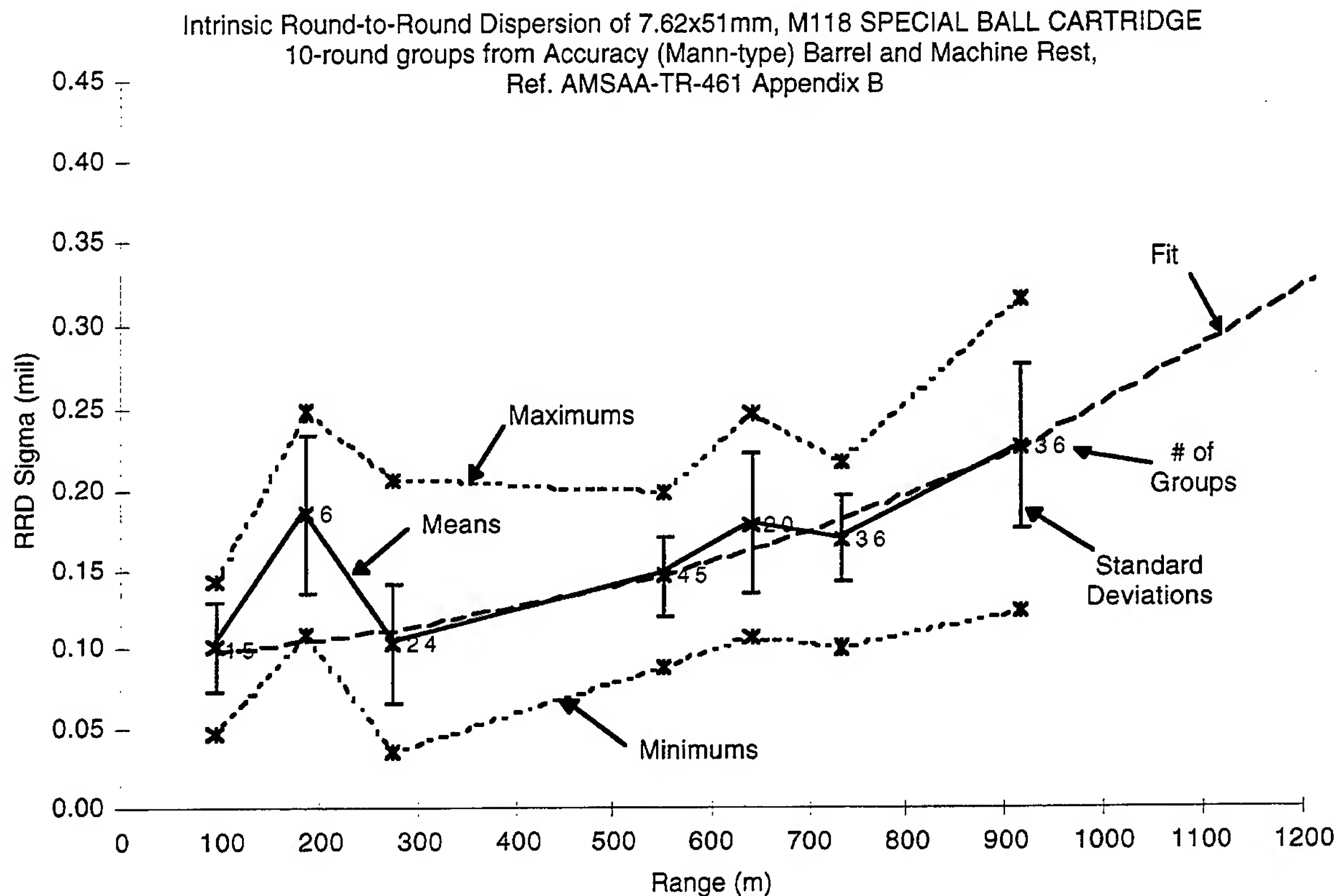

Figure A-1. RRD Data, M118 SPECIAL BALL CARTRIDGE.

### A.3.2 RRD Data for the 50 CAL MK211

The RRD data for the .50 CAL MK211 are based on test data from References 42 and 32 (Table 2.18). The data are shown in Figure A-2. In Reference 42, three 10-shot groups were benchrest fired from two Barrett M82A1 rifles (Guns 1045 and 1046) by two trained gunners. Dispersion data were collected at 100, 500, and 1000 m. The data were extrapolated to 1500 m. Gun 1046 had approximately 50% larger dispersion than gun 1045 at all ranges. Since each gunner fired the same gun throughout the testing, it is not possible to separate gun performance from shooter skill in the data. Reference 32 (Table 2.18, Note h) reports the dispersion of the MK211 fired from a machine rest, special application sniper rifle (SASR) at 0.25 mil at 600 yards. The data from Reference 42 exceeded this amount. Although the rounds were fired by two trained



gunners during fairly benign conditions, the data presumably include weapon pointing error and possibly other error sources, e.g., crosswind. Therefore, the data for each of the guns in Reference 42 were shifted down so as to pass through this datum. The data were then averaged together. The resulting adjusted data compare well with test data from Reference 32 (Table 2.18), which were obtained from SASR firings in a prone/bipod position during benign conditions at bull's-eye targets at known ranges. Reference 32 (Table 2.18) considers this to be total system error and estimates RRD which, in retrospect, might have been better used for the error budget, but this is only an estimate. The MK211 goes subsonic at about 1300 m, and it is believed the dispersion widens greatly after that. At any rate, a reduction in RRD would affect each of the three systems that are being considered equally. Thus, the comparison between the relative effects of adding fire control sophistication would remain the same.

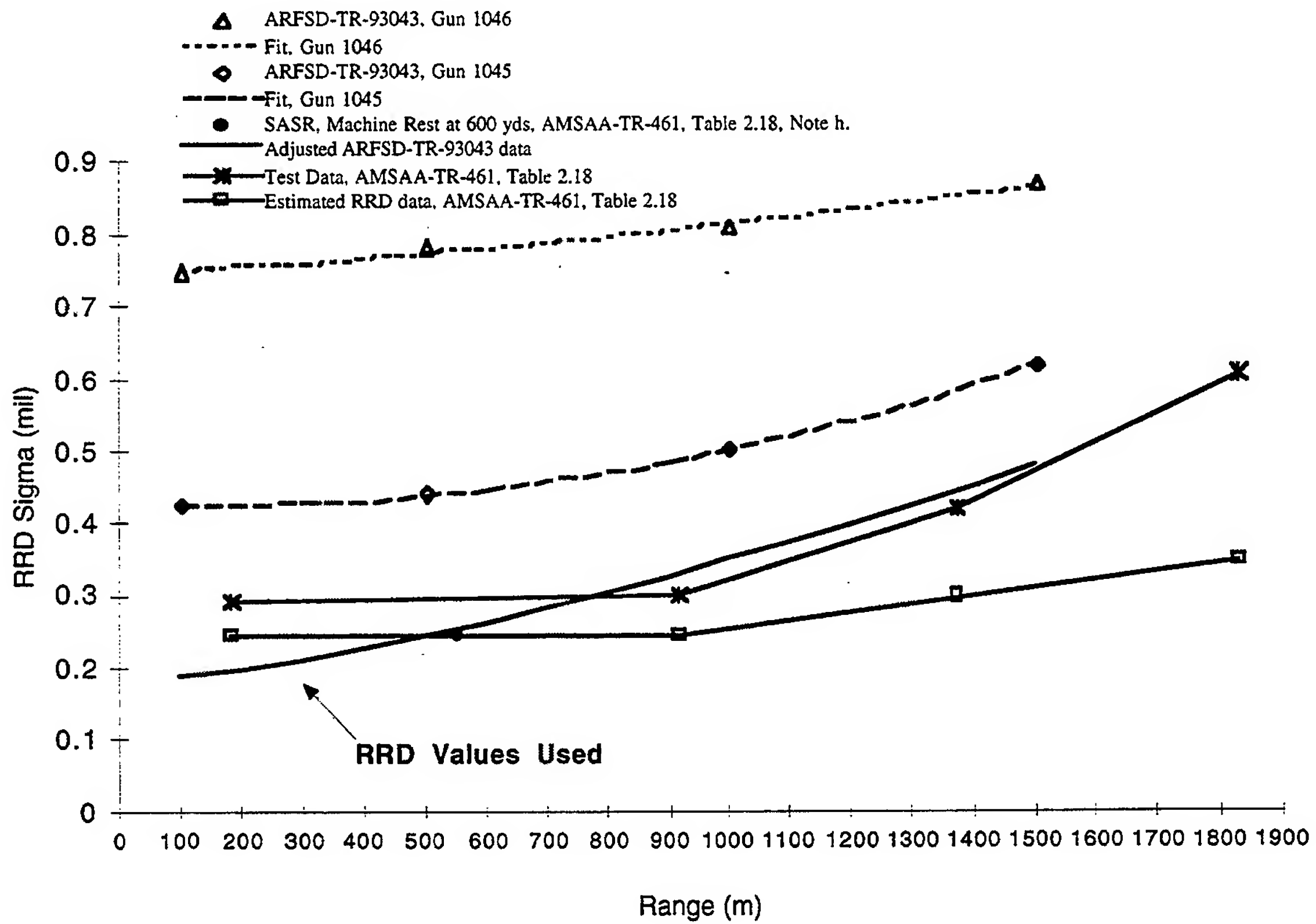

Figure A-2. RRD Data, 50 CAL MK211.

### A.3.3 RRD Data for the .338-.416

RRD is the random error of the bullet attributable to such factors as ballistic jump, slight variations in bullet geometry, etc. The problem with trying to extract a value for RRD

from ammunition dispersion test data is that such data are a composite of all error sources that were present at the time of testing. Many of these are difficult if not impossible to quantify. Dispersion data labeled as the “intrinsic” RRD of the ammunition may also include errors such as muzzle velocity variation, weapon pointing error, atmospheric distortion of the target aim point, and crosswind variation (especially at long ranges).

For the .338-.416 dispersion tests, attempts were made to account for both crosswind and muzzle velocity variations. Crosswind was measured via five down-range anemometers. Velocity was measured by Weibel radar. When possible, the computed portion of the dispersion attributable to these factors was removed from the overall dispersion of a group. The uncorrected and corrected horizontal and vertical standard deviations of the .338 to .416 shot groups are listed in Table A-20, along with the measured effective uniform crosswind and muzzle velocity standard deviations. The data are plotted in Figures A-3 and A-4.

Radial standard deviation (RSD) is the square root of the sum of the horizontal and vertical variances (a variance is the square of a standard deviation). RSD is an efficient estimator of the “accuracy” of a pattern of shots because it considers all the information about dispersion in both directions.[43] Because RRD is attributable to bullet factors alone, one would assume an equally random dispersion in both the horizontal and vertical directions. The RSD would be expected to be about the square root of two times the standard deviation of the impact points in either the horizontal or the vertical direction. Thus, a good estimate of RRD might come from computing the RSD of a group and dividing it by the square root of two. In this manner, estimates of RRD for the .338 to .416 were determined.

The RSD values for the pooled ARL groups were fit as a function of range, along with an RSD value derived from a contract requirement that the accuracy of the weapon system be 1/2 inch at 100 yards for a 10-round group. Using Grubbs tables [43], this is equivalent to an RSD value of 0.05 mil. The Aberdeen Test Center data were not included in the fit primarily because the 1000-m data seemed inconsistent with the apparent trend. The author even entertained the thought that the data for 1000 m and 1400 m were inadvertently switched, but that apparently was not the case. The author has no record of the firing conditions during the two different occasions that the 1000-m and 1400-m groups were shot, so neither set could be corrected for wind or velocity variations. Perhaps the conditions were not as favorable for the 1000-m groups, or, since it was the first time the shooters had handled the rifle during the 1000-m firings, perhaps they were just then getting the feel for the weapon and showed marked improvement when they

next shot at 1400 m. The RSD and derived RRD values for the .338-.416 are plotted in Figure A-5.

Table A-20. Dispersion Data for the .338-.416

Range (m)	Gunner	Group/ No. Rounds	Uncorrected Standard Deviation (mils) Corrections		Corrected Standard Deviation		RSD (mils)
			Horiz.	Vert.	(mils)	(mils)	
			Crosswind m/s - mils	Velocity m/s - mils	Horiz.	Vert.	
490	ARL A	No. 1/10	0.081 0.26-0.037	0.093 1.61-0.012	0.072	0.092	Pooled 0.096
490	ARL A	No. 2/10	0.060 0.33-0.047	0.081 1.93-0.015	0.037	0.080	
490	ARL A	Muffler No. 1/10	0.162	0.130	NA	NA	NA
490	ARL A	Muffler No. 2/10	0.198	0.152	NA	NA	
800	ARL B	No. 1/10	0.132 0.31-0.077	0.067 2.49-0.037	0.107	0.056	Pooled 0.109
800	ARL B	No. 2/10	0.134	0.072 3.48-0.051	NA	0.052	
1000	ARL B	No. 1/10	0.161 0.28-0.093	0.074 1.82-0.038	0.131	0.063	Pooled 0.108
1000	ARL B	No. 2/10	0.070 0.15-0.050	0.084 2.26-0.046	0.049	0.070	
1200	ARL B	No. 1/10	0.130	0.102 2.68-0.072	NA	0.073	Pooled 0.143
1200	ARL B	No. 2/10	0.121 0.06-0.026	0.121 1.65-0.044	0.118	0.112	
1000	ATC 1	No. 1/5	0.168	0.221	NA	NA	0.248
1000	ATC 2	No. 1/5	0.173	0.110	NA	NA	0.183
1000	ATC 3	No. 1/5	0.249	0.178	NA	NA	0.274
1000	1-3	Pooled/15	0.200	0.175	NA	NA	0.238
1400	ATC 1	No. 1/5	0.092	0.140	NA	NA	0.150
1400	ATC 2	No. 1/5	0.063	0.204	NA	NA	0.191
1400	ATC 3	No. 1/5	0.103	0.110	NA	NA	0.135
1400	1-3	Pooled/15	0.088	0.156	NA	NA	0.161

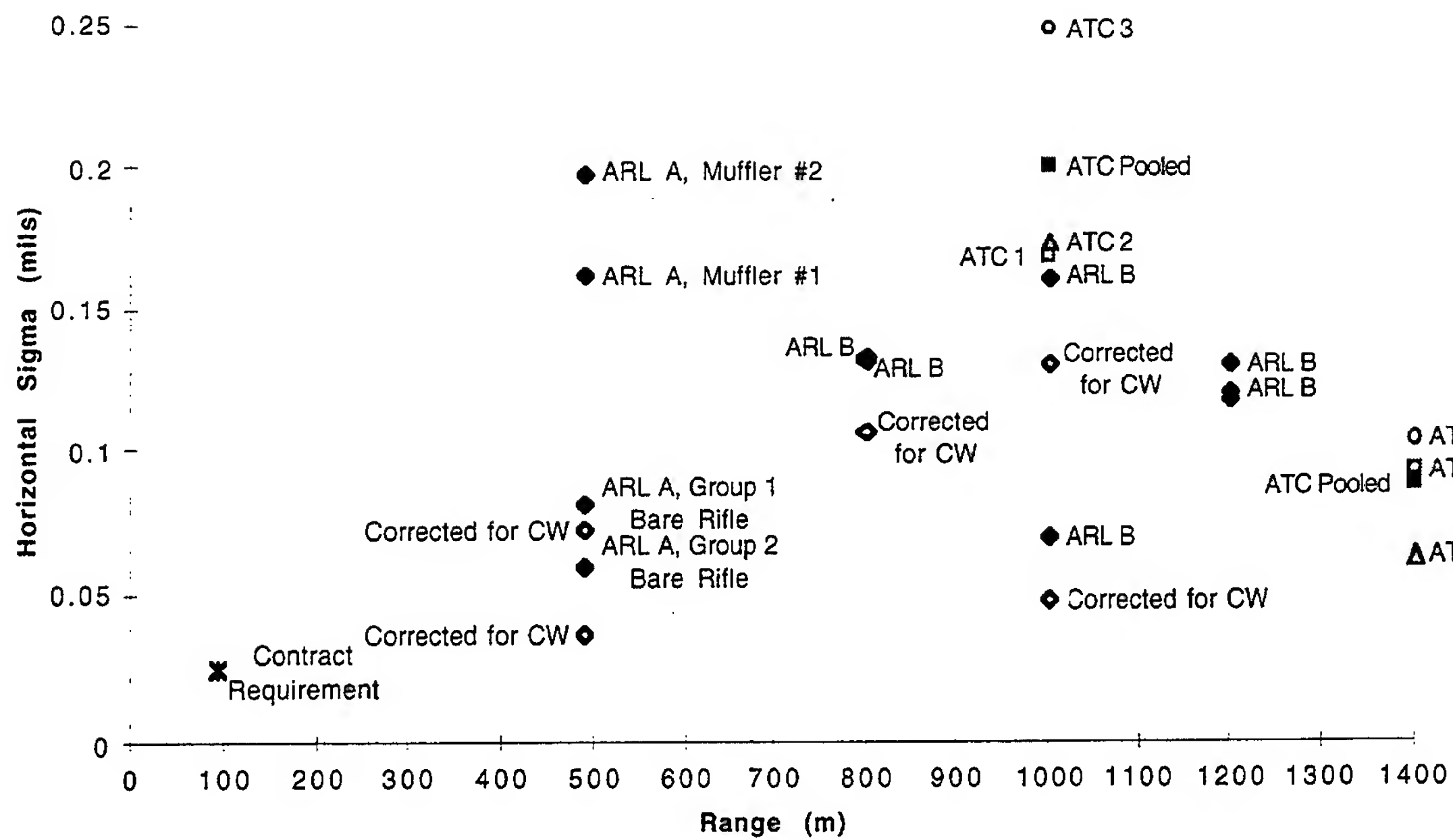

Figure A-3. Horizontal Dispersion Data, .338-.416.

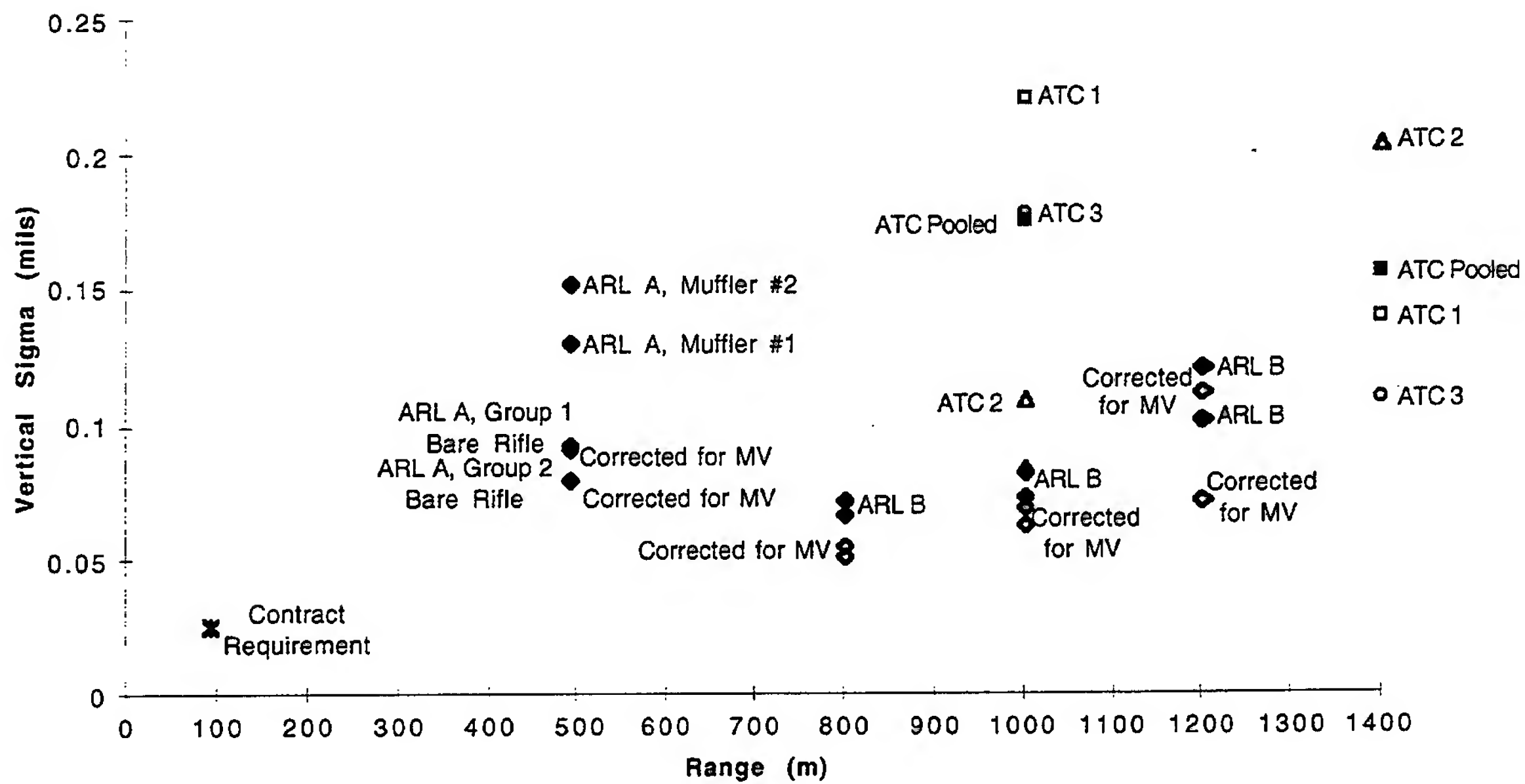

Figure A-4. Vertical Dispersion Data, .338-.416.

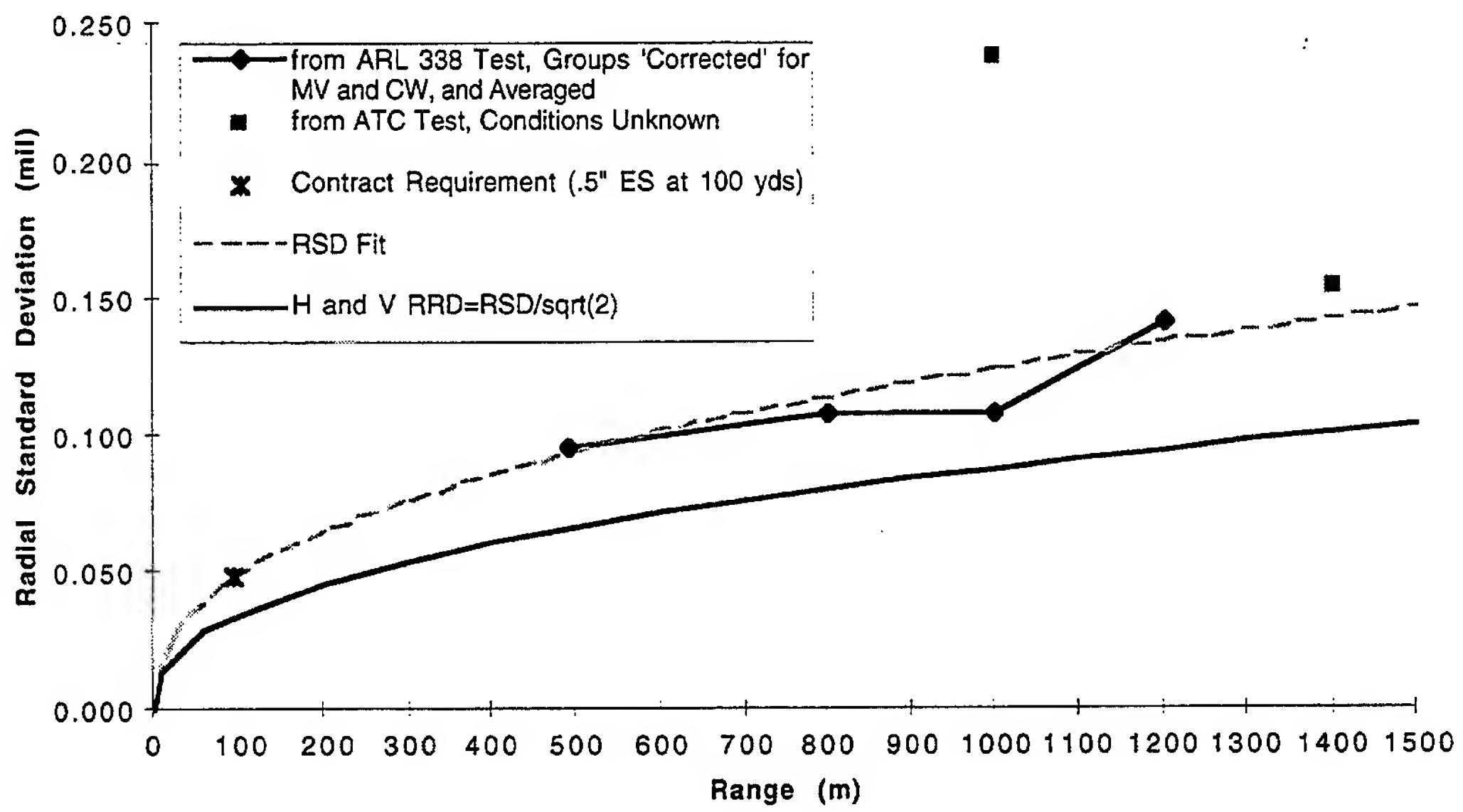

Figure A-5. RRD Data, .338-.416.



INTENTIONALLY LEFT BLANK

APPENDIX B  
RANDOM AND VARIABLE BIAS ERRORS

INTENTIONALLY LEFT BLANK

## RANDOM AND VARIABLE BIAS ERRORS

Tables B-1 and B-2. Total Random and Variable Bias Errors, .300 WinMag

Weapon: M24 Ammunition: .308 CAL SIERRA WinMag Bullet Weight: 190 grains Muzzle Velocity: 2,900 fps						
Total Random Errors (mil)						
Baseline		w/ CW Sensor		w/ Fire Control		
Range (m)	Horizontal	Vertical	Horizontal	Vertical	Horizontal	Vertical
100	0.16	0.15	0.16	0.15	0.15	0.14
200	0.20	0.16	0.20	0.16	0.17	0.15
300	0.25	0.16	0.25	0.16	0.21	0.15
400	0.32	0.17	0.32	0.17	0.26	0.17
500	0.39	0.19	0.39	0.19	0.31	0.18
600	0.47	0.20	0.47	0.20	0.37	0.20
700	0.56	0.22	0.56	0.22	0.44	0.22
800	0.66	0.25	0.66	0.25	0.52	0.24
900	0.78	0.28	0.78	0.28	0.60	0.27
1000	0.90	0.31	0.90	0.31	0.70	0.31
1100	1.03	0.36	1.03	0.36	0.80	0.35
1200	1.17	0.40	1.17	0.40	0.91	0.39
1300	1.31	0.45	1.31	0.45	1.01	0.44
1400	1.44	0.51	1.44	0.51	1.11	0.49
1500	1.56	0.57	1.56	0.57	1.20	0.54

Total Variable Bias Errors (mil)						
Baseline		w/ CW Sensor		w/ Fire Control		
Range (m)	Horizontal	Vertical	Horizontal	Vertical	Horizontal	Vertical
100	0.11	0.06	0.07	0.05	0.05	0.05
200	0.21	0.10	0.11	0.05	0.05	0.05
300	0.33	0.15	0.16	0.06	0.05	0.05
400	0.45	0.22	0.21	0.07	0.05	0.06
500	0.58	0.30	0.27	0.08	0.05	0.06
600	0.72	0.40	0.34	0.10	0.05	0.07
700	0.88	0.53	0.41	0.13	0.05	0.09
800	1.05	0.69	0.49	0.17	0.05	0.10
900	1.24	0.88	0.58	0.23	0.05	0.12
1000	1.44	1.13	0.68	0.31	0.05	0.14
1100	1.66	1.44	0.78	0.42	0.05	0.17
1200	1.90	1.79	0.89	0.51	0.05	0.21
1300	2.12	2.15	1.00	0.56	0.05	0.24
1400	2.33	2.53	1.11	0.57	0.05	0.27
1500	2.53	2.93	1.21	0.59	0.05	0.30

Tables B-3 and B-4. Total Random and Variable Bias Errors, .50 CAL MK211

Weapon: .50 Barrett M82A1 Ammunition: MK211 Bullet Weight: 670 grains Muzzle Velocity: 2,715 fps						
Total Random Errors (mil)						
Range (m)	Baseline		w/ CW Sensor		w/ Fire Control	
	Horizontal	Vertical	Horizontal	Vertical	Horizontal	Vertical
100	0.28	0.28	0.28	0.28	0.22	0.21
200	0.31	0.29	0.31	0.29	0.24	0.22
300	0.34	0.30	0.34	0.30	0.26	0.24
400	0.37	0.31	0.37	0.31	0.30	0.25
500	0.42	0.33	0.42	0.33	0.33	0.27
600	0.48	0.34	0.48	0.34	0.38	0.29
700	0.54	0.36	0.54	0.36	0.43	0.31
800	0.61	0.38	0.61	0.38	0.48	0.33
900	0.68	0.40	0.68	0.40	0.54	0.36
1000	0.76	0.43	0.76	0.43	0.60	0.39
1100	0.84	0.46	0.84	0.46	0.67	0.42
1200	0.93	0.49	0.93	0.49	0.74	0.45
1300	1.03	0.53	1.03	0.53	0.81	0.49
1400	1.13	0.57	1.13	0.57	0.89	0.53
1500	1.23	0.61	1.23	0.61	0.97	0.57

Total Variable Bias Errors (mil)						
Range (m)	Baseline		w/ CW Sensor		w/ Fire Control	
	Horizontal	Vertical	Horizontal	Vertical	Horizontal	Vertical
100	0.12	0.10	0.10	0.09	0.07	0.07
200	0.19	0.13	0.12	0.09	0.07	0.07
300	0.28	0.17	0.15	0.09	0.07	0.07
400	0.37	0.23	0.19	0.10	0.07	0.08
500	0.47	0.30	0.24	0.11	0.07	0.09
600	0.58	0.39	0.29	0.12	0.07	0.09
700	0.70	0.49	0.34	0.14	0.07	0.11
800	0.82	0.62	0.40	0.16	0.07	0.12
900	0.95	0.76	0.46	0.20	0.07	0.13
1000	1.09	0.93	0.53	0.24	0.07	0.15
1100	1.24	1.13	0.60	0.29	0.07	0.17
1200	1.39	1.37	0.68	0.36	0.07	0.20
1300	1.56	1.64	0.76	0.43	0.07	0.23
1400	1.73	1.95	0.84	0.51	0.07	0.26
1500	1.91	2.29	0.93	0.56	0.07	0.29



Tables B-5 and B-6 Total Random and Variable Bias Errors, M118LR

Weapon: Knight SSW, SR25 Ammunition: M118LR Bullet Weight: 175 grains Muzzle Velocity: 2,600 fps						
Total Random Errors (mil)						
Range (m)	Baseline		w/ CW Sensor		w/ Fire Control	
	Horizontal	Vertical	Horizontal	Vertical	Horizontal	Vertical
100	0.17	0.15	0.17	0.15	0.15	0.14
200	0.21	0.16	0.21	0.16	0.18	0.15
300	0.28	0.17	0.28	0.17	0.23	0.16
400	0.35	0.18	0.35	0.18	0.28	0.17
500	0.44	0.19	0.44	0.19	0.35	0.18
600	0.53	0.21	0.53	0.21	0.42	0.20
700	0.64	0.24	0.64	0.24	0.50	0.23
800	0.75	0.26	0.75	0.26	0.58	0.26
900	0.88	0.30	0.88	0.30	0.68	0.29
1000	1.01	0.34	1.01	0.34	0.78	0.33
1100	1.14	0.39	1.14	0.39	0.88	0.37
1200	1.27	0.44	1.27	0.44	0.98	0.42
1300	1.39	0.49	1.39	0.49	1.07	0.47
1400	1.51	0.54	1.51	0.54	1.16	0.52
1500	1.62	0.60	1.62	0.60	1.25	0.57

Total Variable Bias Errors (mil)						
Range (m)	Baseline		w/ CW Sensor		w/ Fire Control	
	Horizontal	Vertical	Horizontal	Vertical	Horizontal	Vertical
100	0.13	0.07	0.08	0.05	0.05	0.05
200	0.25	0.12	0.12	0.05	0.05	0.05
300	0.38	0.18	0.18	0.06	0.05	0.06
400	0.52	0.26	0.25	0.07	0.05	0.07
500	0.68	0.36	0.32	0.09	0.05	0.08
600	0.84	0.48	0.40	0.11	0.05	0.09
700	1.02	0.63	0.48	0.15	0.05	0.11
800	1.21	0.81	0.57	0.19	0.05	0.13
900	1.42	1.03	0.67	0.25	0.05	0.16
1000	1.64	1.29	0.77	0.32	0.05	0.19
1100	1.86	1.58	0.88	0.37	0.05	0.22
1200	2.08	1.89	0.99	0.42	0.05	0.26
1300	2.28	2.21	1.09	0.45	0.05	0.29
1400	2.47	2.56	1.19	0.53	0.05	0.32
1500	2.65	2.92	1.29	0.64	0.05	0.35

Tables B-7 and B-8. Total Random and Variable Bias Errors, .338-.416

Weapon: Testbed .338 Ammo: .338-.416 Bullet Weight: 300 grains Muzzle Velocity: 3040 fps						
Total Random Errors (mil)						
Range (m)	Baseline		w/ CW Sensor		w/ Fire Control	
	Horizontal	Vertical	Horizontal	Vertical	Horizontal	Vertical
100	0.126	0.122	0.126	0.122	0.111	0.108
200	0.144	0.126	0.144	0.126	0.124	0.113
300	0.169	0.130	0.169	0.130	0.142	0.118
400	0.201	0.135	0.201	0.135	0.164	0.123
500	0.236	0.140	0.236	0.140	0.190	0.128
600	0.277	0.145	0.277	0.145	0.220	0.134
700	0.321	0.151	0.321	0.151	0.252	0.141
800	0.369	0.159	0.369	0.159	0.287	0.148
900	0.421	0.167	0.421	0.167	0.325	0.157
1000	0.477	0.177	0.477	0.177	0.366	0.167
1100	0.537	0.188	0.537	0.188	0.410	0.179
1200	0.601	0.202	0.601	0.202	0.458	0.192
1300	0.669	0.218	0.669	0.218	0.509	0.208
1400	0.743	0.238	0.743	0.238	0.563	0.226
1500	0.822	0.261	0.822	0.261	0.622	0.247

Total Variable Bias Errors (mil)						
Range (m)	Baseline		w/ CW Sensor		w/ Fire Control	
	Horizontal	Vertical	Horizontal	Vertical	Horizontal	Vertical
100	0.070	0.050	0.049	0.040	0.035	0.035
200	0.128	0.079	0.070	0.042	0.035	0.037
300	0.191	0.116	0.098	0.045	0.035	0.040
400	0.259	0.160	0.129	0.052	0.035	0.044
500	0.332	0.211	0.163	0.062	0.035	0.050
600	0.410	0.270	0.199	0.079	0.035	0.057
700	0.492	0.336	0.238	0.098	0.035	0.065
800	0.579	0.413	0.280	0.125	0.035	0.075
900	0.673	0.502	0.325	0.159	0.035	0.087
1000	0.771	0.604	0.372	0.202	0.035	0.099
1100	0.876	0.722	0.423	0.254	0.035	0.114
1200	0.988	0.858	0.478	0.317	0.035	0.130
1300	1.108	1.017	0.536	0.394	0.035	0.149
1400	1.236	1.202	0.599	0.487	0.035	0.170
1500	1.372	1.416	0.667	0.597	0.035	0.194

APPENDIX C

NUMBER OF ROUNDS TO HIT E-SILHOUETTE TARGET

INTENTIONALLY LEFT BLANK

NUMBER OF ROUNDS TO HIT E-SILHOUETTE TARGET

Table C-1. Number of Rounds to Hit an E-silhouette Target, 300 WinMag

Weapon: M24 Ammunition: 300 CAL SIERRA WinMag Bullet Weight: 190 grains Muzzle Velocity: 2,900 fps												
Number of rounds to ensure at least one hit of an E-silhouette target with confidence level equal to or greater than X%.												
Range (m)	Baseline			w/ CW Sensor			w/ Fire Control			Round-to-Round Dispersion Only		
	90%	95%	99%	90%	95%	99%	90%	95%	99%	90%	95%	99%
100	1	1	1	1	1	1	1	1	1	1	1	1
200	1	1	1	1	1	1	1	1	1	1	1	1
300	1	1	2	1	1	1	1	1	1	1	1	1
400	2	3	3	1	2	2	1	1	1	1	1	1
500	4	4	6	2	3	4	2	2	2	1	1	1
600	6	8	11	3	4	6	2	3	4	1	1	1
700	11	14	20	5	6	9	3	4	5	1	1	2
800	20	26	37	7	9	13	4	5	8	2	2	2
900	36	47	67	11	15	21	6	8	11	2	2	3
1000	65	84	121	18	23	33	9	12	17	3	3	5
1100	114	146	212	30	38	55	14	17	25	4	5	7
1200	190	245	355	46	59	86	20	26	37	5	7	9
1300	299	384	556	66	85	123	29	37	53	7	9	13
1400	446	574	831	90	115	166	40	52	75	10	13	19
1500	643	827	1029	118	152	220	55	71	103	14	18	26



Table C-2. Number of Rounds to Hit an E-silhouette Target, 50 CAL MK211

Weapon: .50 Barrett M82A1 Ammunition: MK211 Bullet Weight: 670 grains Muzzle Velocity: 2,715 fps												
Number of rounds to ensure at least one hit of an E-silhouette target with confidence level equal to or greater than X%.												
Range (m)	Baseline			w/ CW Sensor			w/ Fire Control			Round-to-Round Dispersion Only		
	90%	95%	99%	90%	95%	99%	90%	95%	99%	90%	95%	99%
100	1	1	1	1	1	1	1	1	1	1	1	1
200	1	1	1	1	1	1	1	1	1	1	1	1
300	2	2	2	1	1	2	1	1	1	1	1	1
400	2	2	3	2	2	3	2	2	2	1	1	1
500	3	4	6	2	3	4	2	2	3	1	1	2
600	6	7	10	3	4	6	2	3	4	2	2	2
700	10	12	17	5	6	9	3	4	6	2	2	3
800	16	21	30	8	10	14	5	6	8	3	3	4
900	27	35	50	11	14	20	7	8	12	3	4	6
1000	45	60	83	16	21	30	9	12	17	5	6	8
1100	72	93	134	23	30	43	13	17	24	6	8	11
1200	114	150	212	34	44	63	18	23	33	8	10	15
1300	176	227	328	49	63	91	25	32	46	11	13	19
1400	266	342	495	69	89	128	34	44	63	14	17	25
1500	389	501	724	94	121	175	46	59	85	17	23	32

Table C-3. Number of Rounds to Hit an E-silhouette Target, M118LR

Weapon: Knight SSW, SR25 Ammunition: M118LR														
Bullet Weight: 175 grains Muzzle Velocity: 2600 fps														
Number of rounds to ensure at least one hit of an E-silhouette target with confidence level equal to or greater than X%.														
Range (m)	Baseline			w/ CW Sensor			w/ Fire Control			Round-to-Round Dispersion Only				
	90%	95%	99%	90%	95%	99%	90%	95%	99%	90%	95%	99%		
100	1	1	1	1	1	1	1	1	1	1	1	1	1	1
200	1	1	1	1	1	1	1	1	1	1	1	1	1	1
300	1	2	2	1	1	1	1	1	1	1	1	1	1	1
400	2	3	4	2	2	3	1	1	2	1	1	1	1	1
500	4	5	7	3	3	4	2	2	3	1	1	1	1	1
600	8	10	14	4	5	7	2	3	4	1	1	1	1	1
700	14	18	26	6	7	11	4	4	6	1	1	1	1	2
800	26	34	48	9	11	16	5	6	9	2	2	2	2	2
900	48	61	88	14	17	25	7	9	13	2	2	3	3	3
1000	83	107	155	21	27	39	11	14	20	3	3	5	5	5
1100	139	179	259	32	41	60	16	21	30	4	5	7	7	7
1200	220	283	409	47	61	88	24	31	44	5	7	9	9	9
1300	329	423	613	66	85	122	34	43	62	7	9	13	13	13
1400	477	613	888	94	121	175	46	59	85	10	13	19	19	19
1500	670	863	1029	134	172	249	62	79	115	14	18	26	26	26

Table C-4. Number of Rounds to Hit an E-silhouette Target, .338-.416

Weapon: Testbed .338 Ammunition: .338-.416												
Bullet Weight: 300 grains Muzzle Velocity: 3040 fps												
Number of rounds to ensure at least one hit of an E-silhouette target with confidence level equal to or greater than X%.												
Range (m)	Baseline			w/ CW Sensor			w/ Fire Control			Round-to-Round Dispersion Only		
	90%	95%	99%	90%	95%	99%	90%	95%	99%	90%	95%	99%
100	1	1	1	1	1	1	1	1	1	1	1	1
200	1	1	1	1	1	1	1	1	1	1	1	1
300	1	1	1	1	1	1	1	1	1	1	1	1
400	1	1	2	1	1	1	1	1	1	1	1	1
500	2	2	3	1	2	2	1	1	1	1	1	1
600	3	4	5	2	2	3	1	2	2	1	1	1
700	5	6	8	3	3	5	2	2	3	1	1	1
800	7	9	13	4	5	6	2	3	4	1	1	1
900	12	15	22	5	6	9	3	4	5	1	1	1
1000	19	25	36	7	9	13	4	5	7	1	1	1
1100	31	39	57	10	13	18	5	6	9	1	1	1
1200	48	62	89	15	19	27	6	8	12	1	1	2
1300	76	95	137	22	29	41	9	11	16	1	1	2
1400	112	144	208	34	43	63	12	15	21	1	2	2
1500	167	215	311	51	66	95	16	20	29	2	2	2

APPENDIX D  
SENSITIVITY ANALYSIS

INTENTIONALLY LEFT BLANK



# SENSITIVITY ANALYSIS

## 300 WINMAG, Baseline System

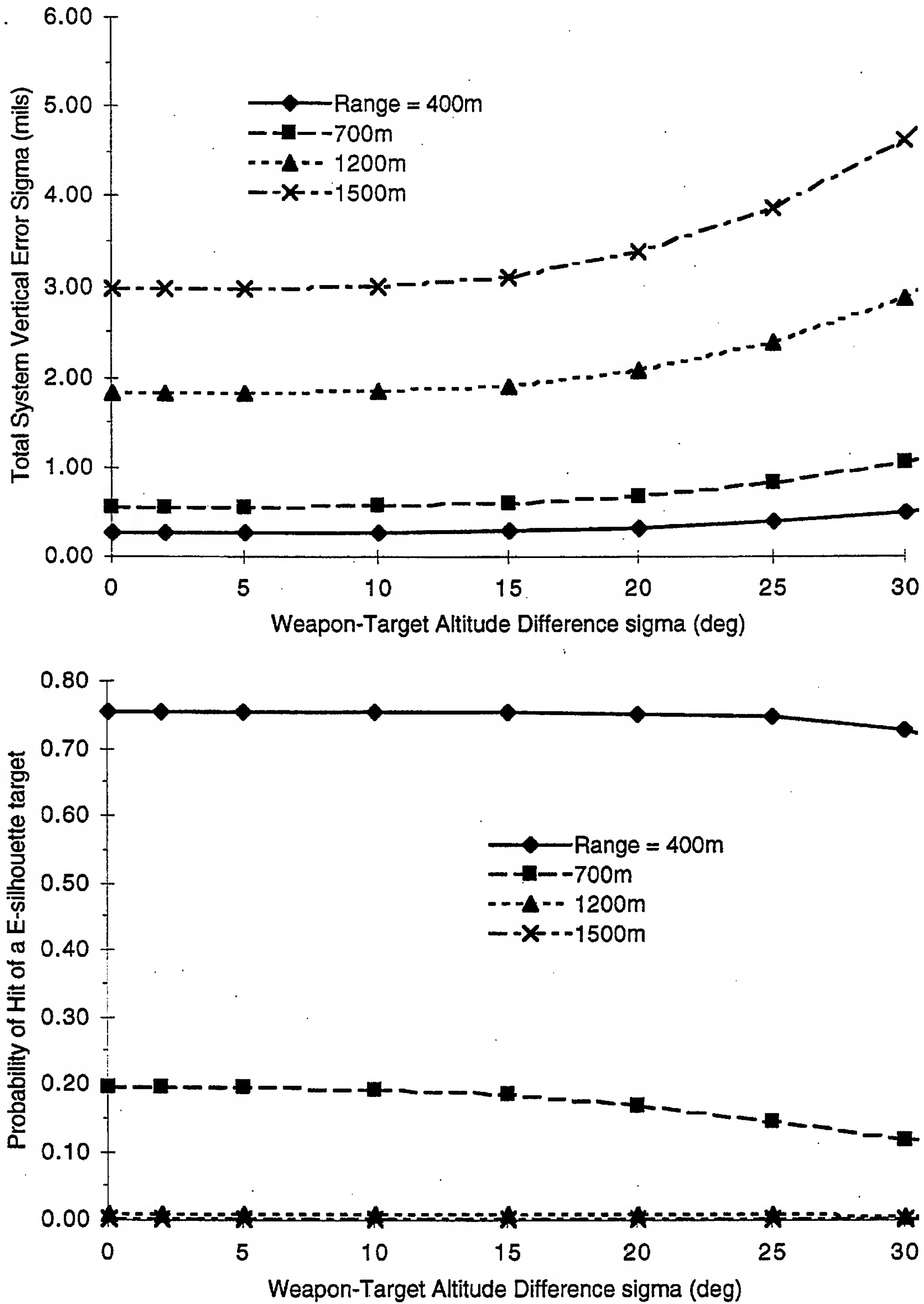

Figure D-1. Error Budget Sensitivity, Weapon-Target Altitude Difference.

### 300 WINMAG, Baseline System

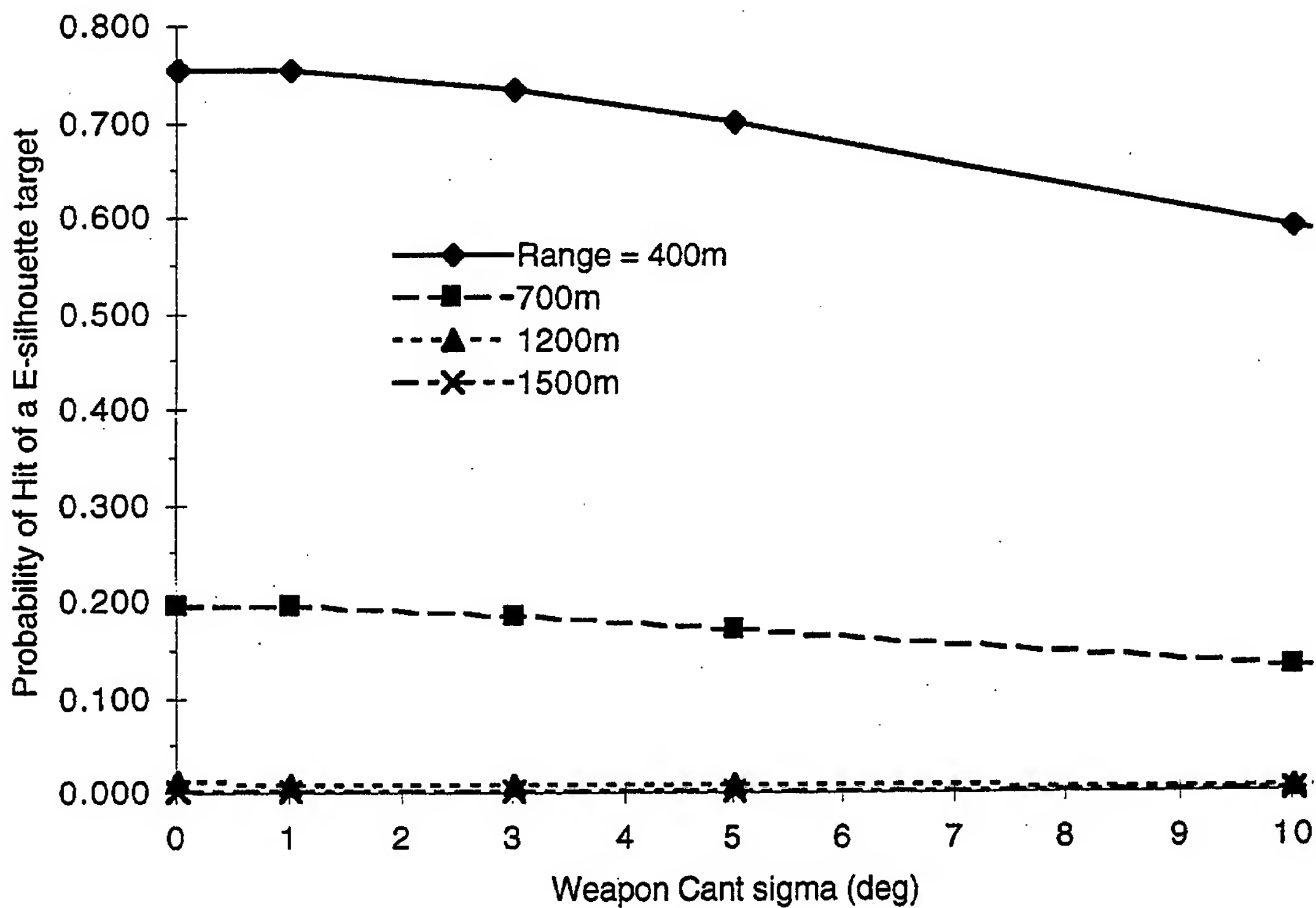
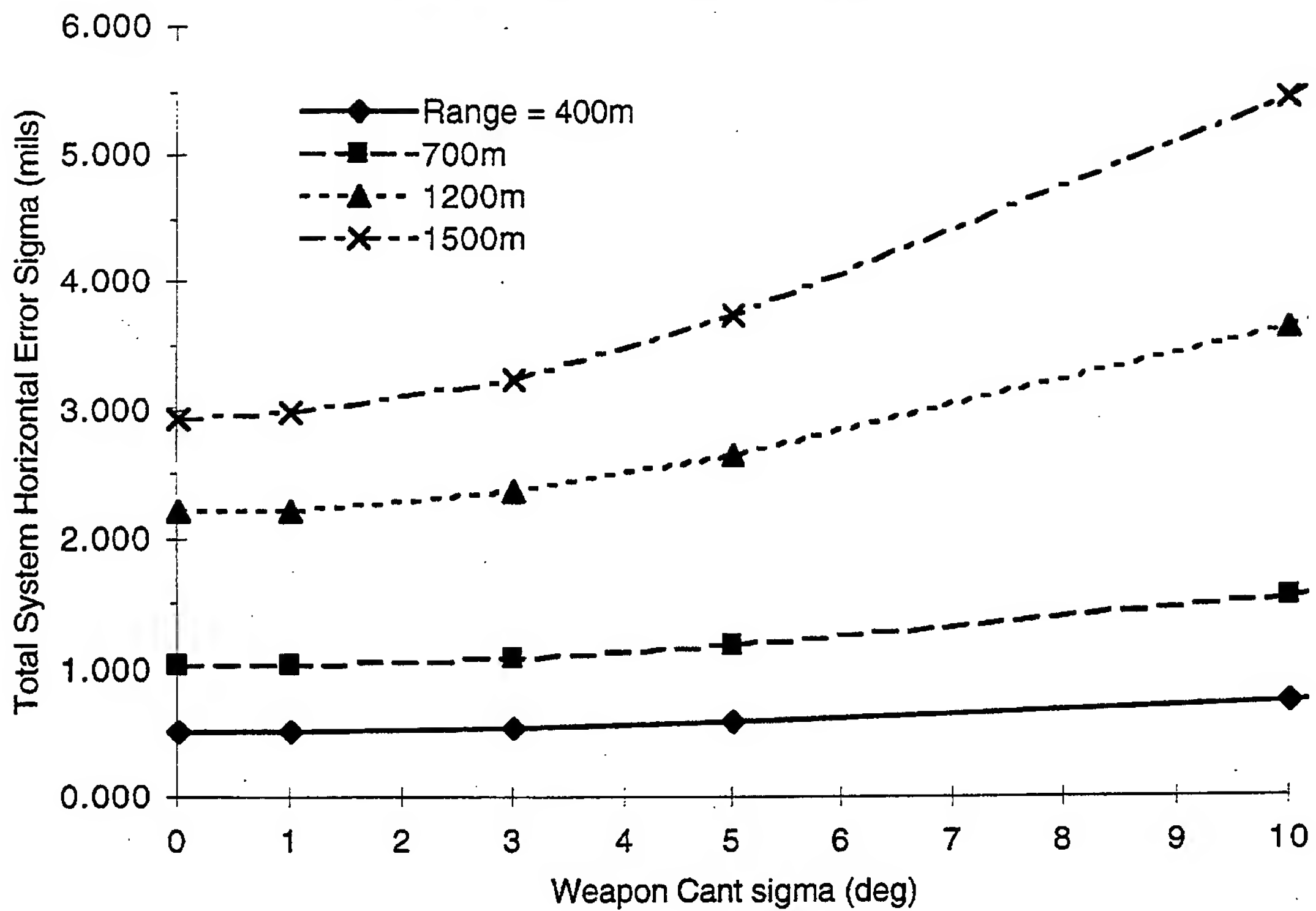

Figure D-2. Error Budget Sensitivity, Weapon Cant.

### 300 WINMAG, Baseline System

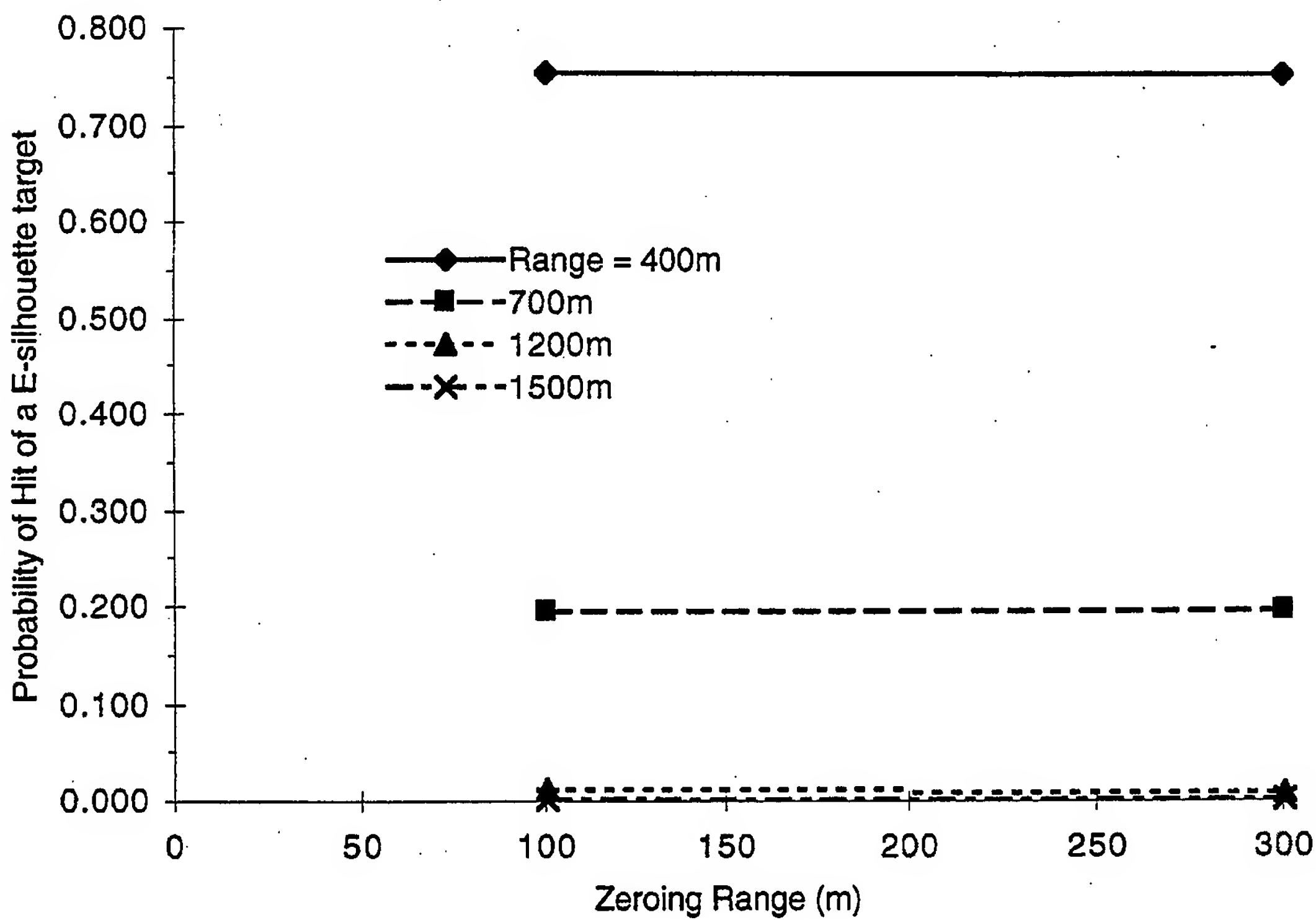
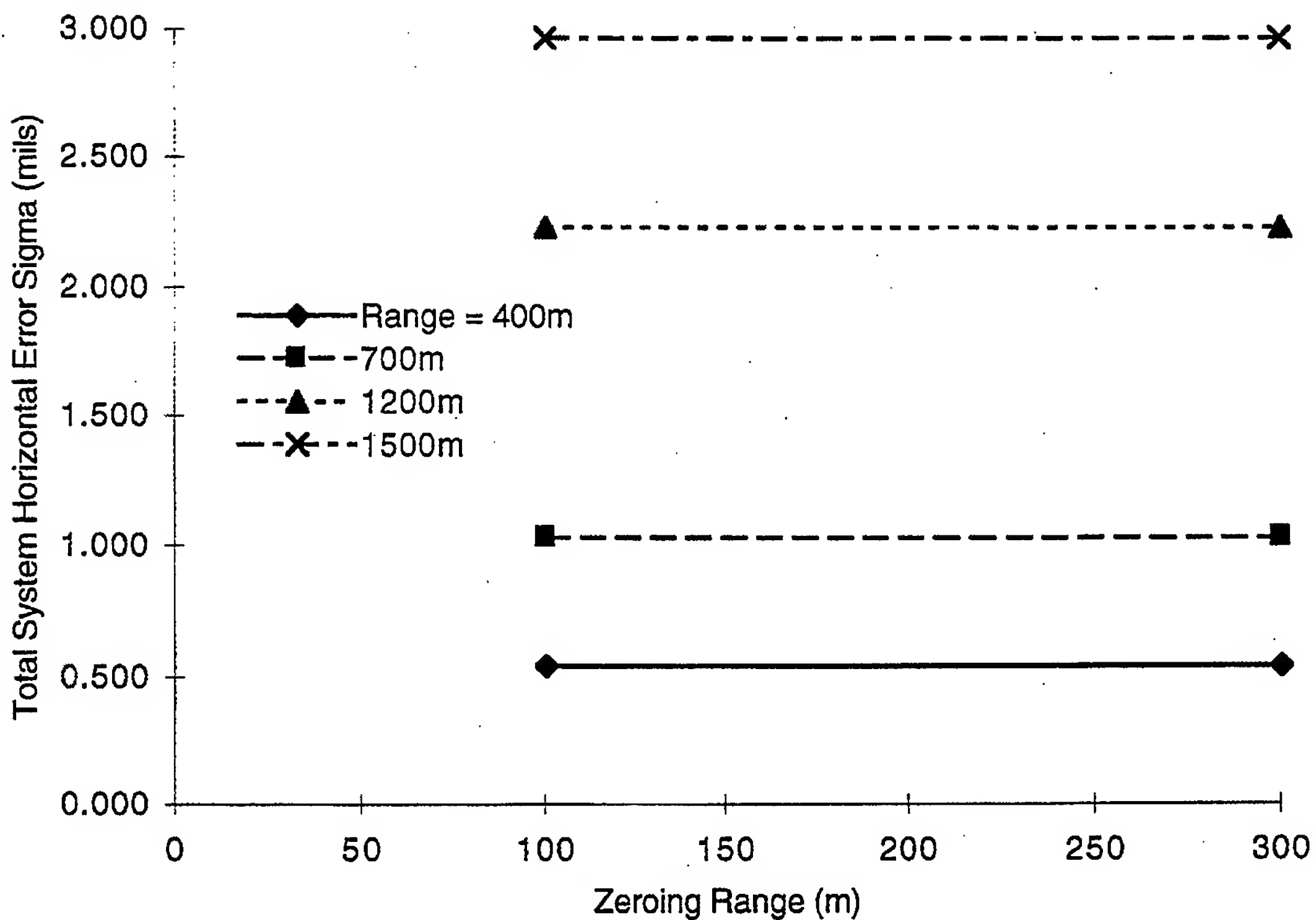

Figure D-3. Error Budget Sensitivity Zeroing Range.

INTENTIONALLY LEFT BLANK

<u>NO. OF COPIES</u>	<u>ORGANIZATION</u>
2	ADMINISTRATOR DEFENSE TECHNICAL INFO CENTER ATTN DTIC OCP 8725 JOHN J KINGMAN RD STE 0944 FT BELVOIR VA 22060-6218
1	DIRECTOR US ARMY RESEARCH LABORATORY ATTN AMSRL CS AL TA REC MGMT 2800 POWDER MILL RD ADELPHI MD 20783-1197
1	DIRECTOR US ARMY RESEARCH LABORATORY ATTN AMSRL CI LL TECH LIB 2800 POWDER MILL RD ADELPHI MD 207830-1197
1	DIRECTOR US ARMY RESEARCH LABORATORY ATTN AMSRL DD J J ROCCHIO 2800 POWDER MILL RD ADELPHI MD 20783-1197
1	DIRECTOR US ARMY RESEARCH LABORATORY ATTN AMSRL IS EM D GARVEY 2800 POWDER MILL ROAD ADELPHI MD 20783-1145
1	OFC OF THE DIR RSRCH AND ENGRG ATTN R MENZ PENTAGON RM 3E1089 WASHINGTON DC 20301-3080
1	US ARMY TANK AUTOMOTIVE & ARMAMENTS CMD AMSTA AR TD M FISETTE BLDG 1 PICATINNY ARSENAL NJ 07806-5000
2	SIMULATION TECHNOLOGIES INC ATTN D METZ 43 N BOND ST BEL AIR MD 21014
1	EAI CORP ATTN P SMOAK 2111 EISENHOWER AVE SUITE 302 ALEXANDRIA VA 22314
2	EAI CORP ATTN D SLOOP W WILLOUGHBY 1308 CONTINENTAL DR SUITE J ABINGDON MD 21009

<u>NO. OF COPIES</u>	<u>ORGANIZATION</u>
2	ASI SYSTEMS INTERNATIONAL ATTN L NUTSCH W WALTER 56 INVERNESS DRIVE EAST ENGLEWOOD CO 80112-5114
2	OFFICE OF SPECIAL TECHNOLOGY ATTN G SHOCK 10530 RIVERVIEW RD BLDG 3 FORT WASHINGTON MD 20744-2646
2	US SPECIAL OPERATIONS CMD ATTN SOST T W WILLIAMS FLORIDA KEYS BLDG 102 MACDILL AFB FL 33621-5316
1	US SPECIAL OPERATIONS CMD ATTN SOAL SP R BAILER 7701 TAMPA POINT BLVD MACDILL AFB FL 33621-5323
1	FASTMETRIX INC ATTN G KAMERMAN 3313 MEMORIAL PKWY SE SUITE 111 HUNTSVILLE AL 35801-5342
2	SCIENTIFIC TECHNOLOGY INC ATTN TING I WANG CHUNG DYI HSU 205 PERRY PARKWAY SUITE 14 GAITHERSBURG MD 20877
1	OPTICAL AIR DATA SYSTEMS ATTN P ROGERS PO BOX 34601 WEST BETHESDA MD 20827
1	BRIMROSE CORP OF AMERICA ATTN S KUTCHER 5024 CABBELL BLVD BALTIMORE MD 21236-4968
1	COHERENT TECHNOLOGIES INC ATTN P GATT PO BOX 7488 BOULDER CO 80306
1	CONTRAVES BRASHER SYSTEMS ATTN L HARKLESS 615 EPSILON DR PITTSBURGH PA 15238



<u>NO. OF COPIES</u>	<u>ORGANIZATION</u>	<u>NO. OF COPIES</u>	<u>ORGANIZATION</u>
1	SYSTEM PLANNING CORP ATTN E FRIDAY 1000 WILSON BLVD ARLINGTON VA 22209-2211	1	PAUL JOHNSON 118 GOLDEN AVE DAHLONEGA GA 30533
1	DYNCORP DYNMERIDIAN ATTN T BROPHY 2909 BAY TO BAY BLVD TAMPA FL 33629-8161	1	MISTRAL ATTN V COHEN 7910 WOODMONT AVE SUITE 1070 BETHESDA MD 20814
1	PRIMEX TECHNOLOGIES ATTN D WILLIAMS 9236 EAST HALL RD DOWNEY CA 90241	1	CHUCK KARWAN C/O COBAT ARMS PETERSEN PUBLISHING CO 6420 WILSHIRE BLVD LOS ANGELES CA 90048-5515
1	THERMOTREX CORP ATTN R KREMER 10455 PACIFIC CENTER CT SAN DIEGO CA 92121-4339	1	MAJ JOHN PLASTER C/O GUNS & AMMO PETERSEN PUBLISHING CO 6420 WILSHIRE BLVD LOS ANGELES CA 90048-5515
1	WINTEC INC ATTN D MOLENAAR 12821 OLD FORT RD #302 FORT WASHINGTON MD 20744	1	MELVIN EWING 1405 E BROADWAY #K201 MISSOULA MT 59802
1	FEDERAL CARTRIDGE COMPANY ATTN G GRONFOR 900 EHLEN DR ANOKA MN 55303	1	LOCKHEED MARTIN AERONUTRONIC ATTN J HYNES 29947 AVENIDA DE LAS BANDERAS PO BOX 7004 RANCHO SANTA MARGARITA CA 92688-7004
1	FEDERAL CARTRIDGE COMPANY ATTN S KELLY 8029 WILSON TERRACE SPRINGFIELD IL 62707	1	SO RDT&E SUPPORT ELEMENT ATTN T ASSELTA PO BOX 627 OAK GROVE KY 42262
1	KNIGHT'S MANUFACTURING CO ATTN REED KNIGHT 7750 9TH ST SW VERO BEACH LA 32968-9298	1	NAVSPECWARCEN ATTN MIKE HINKLE 2446 TRIDENT WAY SAN DIEGO CA 92155 5494
1	HUGO TEUFEL 6969 SOUTH BEMIS STREET LITTLETON CO 80120	1	PROGRAM OFFICE ATTN SCOTT STORY 991 ANNAPOLIS WAY WOODBIDGE VIRGINIA 22191
1	PRECISION SHOOTING ATTN DAVID BRENNAN 222 MCKEE STREET MANCHESTER CT 06040	7	COMMANDER US ARMY ARDEC ATTN AMSTA AR CCJ S SMALL (2 CYS) AMSTA AR CCJ J GOLDMAN AMSTA AR CCL A T VASS AMSTA AR FSF D K PFLEGER AMSTA AR CCL E F FORTINO L SADOWSKI PICATINNY ARSENAL NJ 07806-5000
1	COMMANDER US ARMY INFANTRY CENTER ATTN ATZB CDS (WALT HADDIGAN) FT BENNING GA 31905-5400		

NO. OF  
COPIES    ORGANIZATION

ABERDEEN PROVING GROUND

2     DIRECTOR  
      US ARMY RESEARCH LABORATORY  
      ATTN AMSRL CI LP (TECH LIB)  
      BLDG 305 APG AA

1     US ARMY ATC  
      ATTN STEAC EN M C CLOUGH  
      BLDG 1134  
      APG MD 21005-5059

2     DIRECTOR  
      US ARMY RESEARCH LABORATORY  
      ATTN AMSRL WM I MAY  
      BLDG 4600

2     DIR USARL  
      ATTN AMSRL WM B A W HORST JR  
              W CIEPIELLA  
      BLDG 4600

14    DIR USARL  
      ATTN AMSRL WM BB H ROGERS  
              B HAUG  
              R VON WAHLDE (12 CYS)  
      BLDG 1121

2     DIR USARL  
      ATTN AMSRL WM BB T BROSSEAU  
              M KREGEL  
      BLDG 390

1     DIR USARL  
      ATTN AMSRL WM BB T VONG  
      BLDG 1120A

1     DIR USARL  
      ATTN AMSRL WM BB S WANSACK  
      BLDG 1116

ABSTRACT ONLY

1     DIRECTOR  
      US ARMY RESEARCH LABORATORY  
      ATTN AMSRL CS AL TP TECH PUB BR  
      2800 POWDER MILL RD  
      ADELPHI MD 20783-1197

INTENTIONALLY LEFT BLANK

# REPORT DOCUMENTATION PAGE

Form Approved  
OMB No. 0704-0188

Public reporting burden for this collection of information is estimated to average 1 hour per response, including the time for reviewing instructions, searching existing data sources, gathering and maintaining the data needed, and completing and reviewing the collection of information. Send comments regarding this burden estimate or any other aspect of this collection of information, including suggestions for reducing this burden, to Washington Headquarters Services, Directorate for Information Operations and Reports, 1215 Jefferson Davis Highway, Suite 1204, Arlington, VA 22202-4302, and to the Office of Management and Budget, Paperwork Reduction Project (0704-0188), Washington, DC 20503.

1. AGENCY USE ONLY (Leave blank)		2. REPORT DATE August 1999	3. REPORT TYPE AND DATES COVERED Final	
4. TITLE AND SUBTITLE  Sniper Weapon Fire Control Error Budget Analysis			5. FUNDING NUMBERS  PR: 1L162618AH80	
6. AUTHOR(S)  Von Wahlde, R. (ARL); Metz, D. (EAI Corp.)				
7. PERFORMING ORGANIZATION NAME(S) AND ADDRESS(ES)  U.S. Army Research Laboratory Weapons & Materials Research Directorate Aberdeen Proving Ground, MD 21010-5066			8. PERFORMING ORGANIZATION REPORT NUMBER	
9. SPONSORING/MONITORING AGENCY NAME(S) AND ADDRESS(ES)  U.S. Army Research Laboratory Weapons & Materials Research Directorate Aberdeen Proving Ground, MD 21010-5066			10. SPONSORING/MONITORING AGENCY REPORT NUMBER  ARL-TR-2065	
11. SUPPLEMENTARY NOTES				
12a. DISTRIBUTION/AVAILABILITY STATEMENT  Approved for public release; distribution is unlimited.			12b. DISTRIBUTION CODE	
13. ABSTRACT (Maximum 200 words)  In order to assess the value added by the application of fire control technology to sniper weapons, "error budgets" are developed as a function of range for several sniper weapon systems. A system is comprised of the weapon and its associated ammunition as well as the type of fire control technology provided that weapon. For this study, a total of four weapon-ammunition combinations were used and three levels of fire control sophistication were examined. The "baseline system" consists of a two-person sniper team using a standard rifle, spotting scope, and laser range finder to make aiming corrections. The "cross-wind system" adds a laser crosswind sensing device and more accurate range finder incorporated into the spotting scope. The "fire control system" performs a full ballistic firing solution and presents a real-time corrected aim point to the shooter. One-sigma system errors and probabilities of hit against an E-silhouette target are calculated.				
14. SUBJECT TERMS			15. NUMBER OF PAGES 85	
			16. PRICE CODE	
17. SECURITY CLASSIFICATION OF REPORT Unclassified	18. SECURITY CLASSIFICATION OF THIS PAGE Unclassified	19. SECURITY CLASSIFICATION OF ABSTRACT Unclassified	20. LIMITATION OF ABSTRACT	